

FACILITY ELECTRICAL PROTECTION

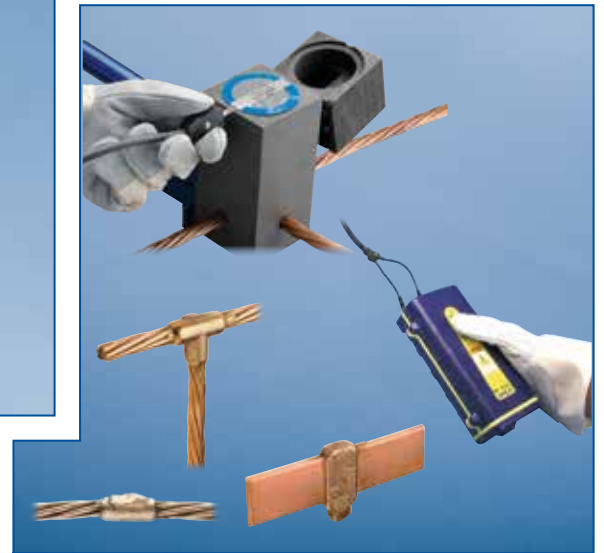



Pentair Engineered Electrical & Fastening Solutions is a leading global manufacturer and marketer of superior engineered products for niche electrical, mechanical and concrete applications. These Pentair products are sold globally under a variety of market-leading brands: ERICO welded electrical connections, facility electrical protection, and rail and industrial products; CADDY fixing, fastening and support products; ERIFLEX low voltage power and grounding connections; and LENTON engineered systems for concrete reinforcement.

Facility Electrical Protection

Lightning protection, grounding, equipotential bonding and surge protection are all interdependent disciplines and the focus of our Facility Electrical Protection product line.

Reliable protection of personnel and structures demands a systematic and comprehensive approach to minimising threats caused by transients and other

system disturbances. For instance, no air terminal can safely capture and arrest the lightning energy without a dependable route to ground. Equally, even the most expensive Surge Protection Device (SPD) will not provide optimum protection if a low-impedance electrical connection to the ground is not present. Additionally, a low-impedance ground system may create hazards to equipment and personnel alike if equipotential bonding is not in place.

These interdependent disciplines are best applied when looking at a total facility rather than an individual piece of equipment or a portion of the facility.

Since no single technology can eliminate the harmful effects of lightning or induced-surge transients, Pentair has developed the Six Point Plan of Protection. The concept behind this plan is a holistic and coordinated approach that embraces all aspects of effective facility electrical protection.

The six interdependent disciplines that form the protection plan are:

1. Capture the lightning strike
2. Convey this energy to ground
3. Dissipate energy into the grounding system
4. Bond all ground points together
5. Protect incoming AC power feeders
6. Protect low voltage data/telecommunications circuits



Facility Electrical Protection







At Pentair, we offer innovative, efficient grounding and bonding products as well as engineering experience and technical support. With this experience, Pentair is a world-leading authority in the design and construction of permanent, low-impedance grounding systems.

Pentair employs a quality-assurance program to help ensure that detailed procedures required for every step of the operation produce the best possible system for our clients. This attention to detail includes design, materials procurement, manufacturing, installation and testing.

Our research and development capabilities provide continuous design improvement with new and improved products that preempt the challenging requirements of ever-evolving industry applications. Engineering expertise is shared among the other Pentair operations worldwide, to provide a comprehensive global knowledge pool.

Trust Pentair for all of your facility electrical protection needs.

Table of Contents

	Technical Information	Pages 4-16
	Lightning Protection	Pages 17-29
	Conductors	Pages 30-32
	Grounding and Bonding	Pages 33-44
	Surge Protection	Pages 45-47
	CADWELD/CADWELD PLUS/CADWELD MULTI	Pages 48-73
	Index	Pages 74-79

CATALOGUE OVERVIEW

Lightning Protection

Point 1 - Capture the lightning strike

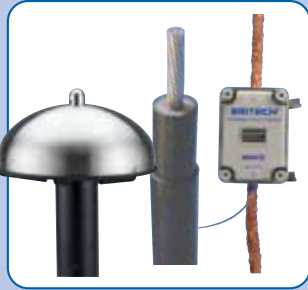

Pages 17 to 19



Pages 22 to 25

Point 2 - Convey this energy to ground



Pages 26 to 29

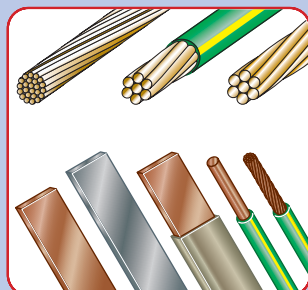

Pages 30 to 32

Pentair Six Point Plan of Protection

Effective lightning protection involves the integration of several concepts. Pentair employs the Six Point Plan of Protection as a useful guide to ensure the highest level of system security.

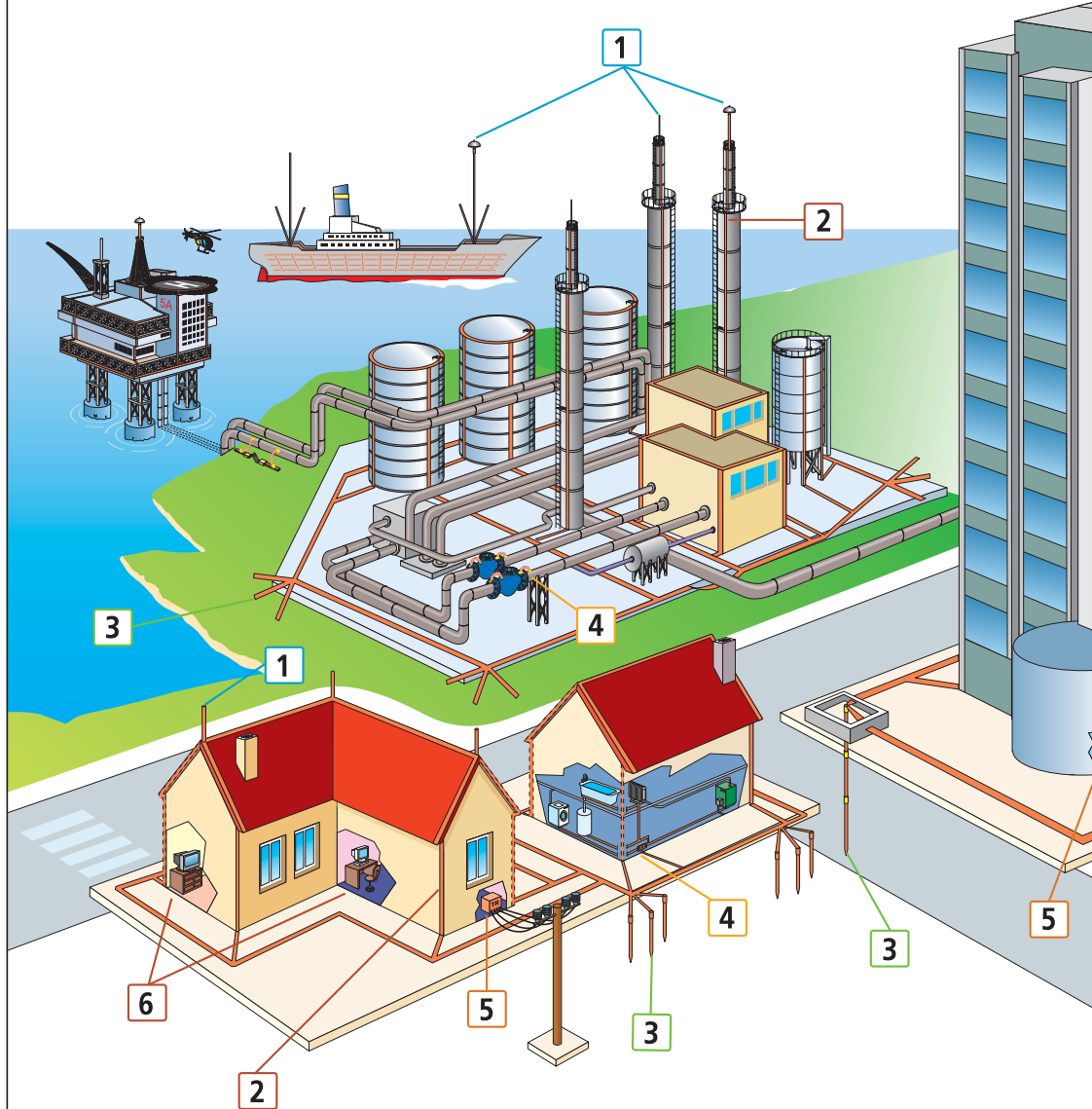

Grounding & Bonding

Point 3 - Dissipate energy into the grounding system

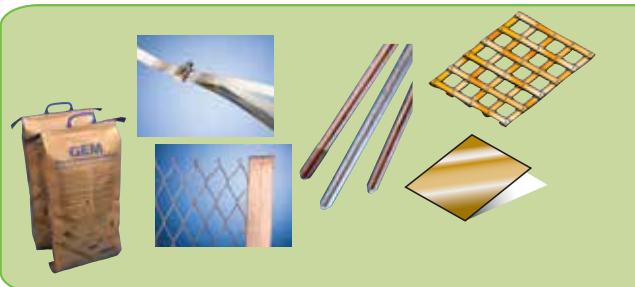

Pages 33 to 39

Point 4 - Bond all ground points together

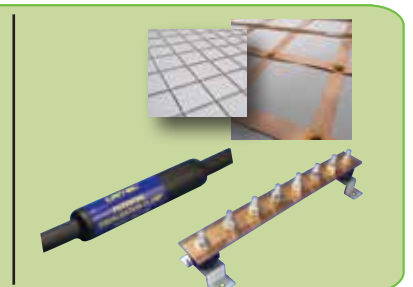

Pages 40 to 44

CATALOGUE OVERVIEW

- 1** Capture the lightning strike. Capture the lightning strike to a known and preferred attachment point using a purpose-designed air terminal system.
- 2** Convey this energy to ground. Conduct the energy to the ground via a purpose-designed downconductor.
- 3** Dissipate energy into the grounding system. Dissipate energy into a low impedance grounding system.
- 4** Bond all ground points together. Bond all ground points to help eliminate ground loops and create an equipotential plane.
- 5** Protect incoming AC power feeders. Protect equipment from surges and transients on incoming power lines to help prevent equipment damage and costly operational downtime.
- 6** Protect low voltage data/telecommunications circuits. Protect equipment from surges and transients on incoming telecommunications and signal lines to help prevent equipment damage and costly operational downtime.

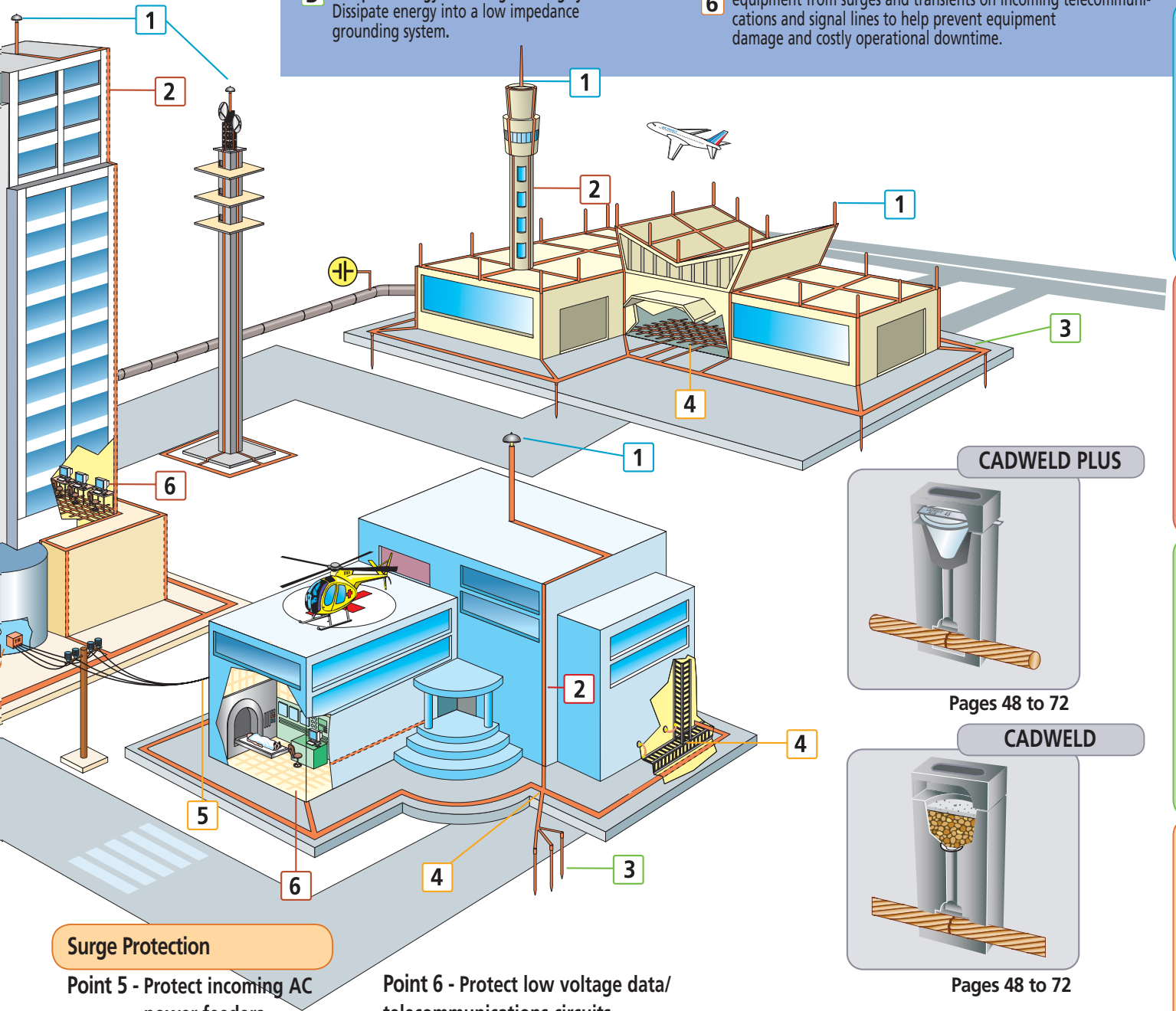

Surge Protection

Point 5 - Protect incoming AC power feeders

Point 6 - Protect low voltage data/telecommunications circuits



Pages 45 to 47

CADWELD PLUS

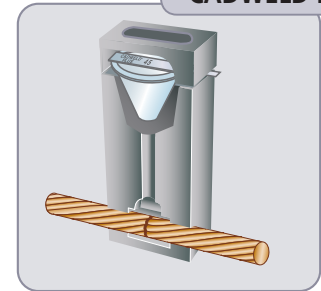

Pages 48 to 72

CADWELD

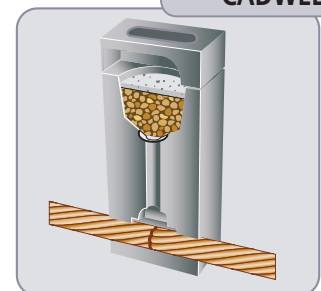

Pages 48 to 72

CADWELD MULTI



Page 48 to 72

TECHNICAL INFORMATION

ERICO SYSTEM 3000

Protection of Structures Against Lightning

There are 2 types of devices for the protection of structures against lightning: the conventional one, based only on passive components (copper, galvanised steel...), and the active protection system, **The latter being based on advanced knowledge and more than 15 years of experience.**

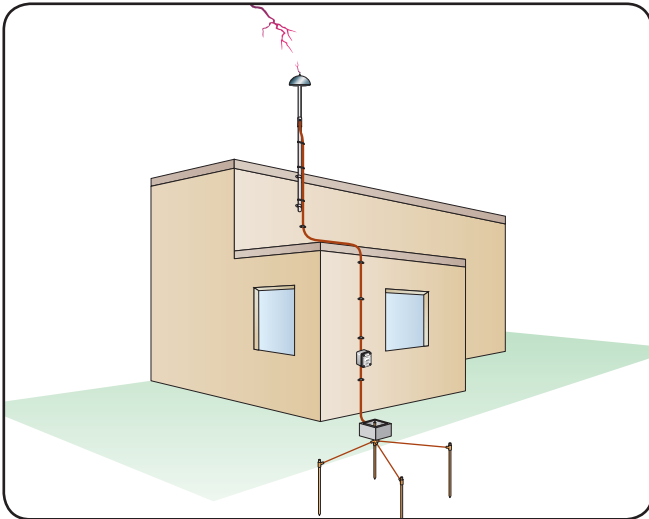

Active Protection

What is the System?

The ERICO SYSTEM 3000 is a technically advanced lightning-protection system. The unique features of this system allow the achievement of superior technical performance and hence provide more reliable lightning capture.

The ERICO DYNASPHERE air terminal provides a preferred point for lightning discharges which would otherwise strike and damage an unprotected structure and/or its contents. The ERICO DYNASPHERE is connected to an ERICO ERICORE downconductor and the ground system in such a way as to provide a totally integrated system.

Protection Level

Lightning is a statistical phenomena where 100% protection is virtually impossible to achieve, and certainly, is not economically practical. IEC® 62305-3 defines 4 protection levels together with associated interception efficiencies. This information is used to determine the appropriate air terminal location and spacing.

LEVEL I	99%	Very high risk structures
LEVEL II	97%	High risk structures
LEVEL III	91%	Medium risk structures
LEVEL IV	84%	Low risk structures, e.g. Residential



Air Terminal

The ERICO DYNASPHERE Enhanced Air Terminal

The patented ERICO DYNASPHERE is an enhanced air terminal.

- Non radioactive
- Not externally powered
- Has no moving parts
- Responds dynamically to the approach of a lightning downleader.

Principles of the ERICO DYNASPHERE

For more than 200 years little improvement was made in lightning protection systems.

Modern research and recording methods have led to a better understanding of the lightning discharge process and various breakthroughs have been achieved in the simulation of lightning electric-field conditions.

Two fundamental concepts have emerged from recent research into the lightning attachment process and air terminal performance:

1. Air terminals that produce copious quantities of corona (space charge) are likely to be less efficient in the interception of a lightning downward leader.
2. An optimum air terminal is one which launches an upward streamer when it is highly likely to convert into a stable, propagating leader (to intercept the downward leader)

The ERICO DYNASPHERE has been developed with these two concepts in mind.

The ERICO DYNASPHERE is an enhanced Franklin rod with a spherical dome which is capacitively coupled to the electric field of an approaching lightning downleader.

This spherical conductive surface surrounds a central earthed lightning rod. The sphere is insulated from the rod but connected to ground via a high impedance with DC conduction.

The ERICO DYNASPHERE is isolated from the structure using an insulated support mast. The mast also enables the safe connection of the ERICO ERICORE downconductor to the air terminal.

TECHNICAL INFORMATION

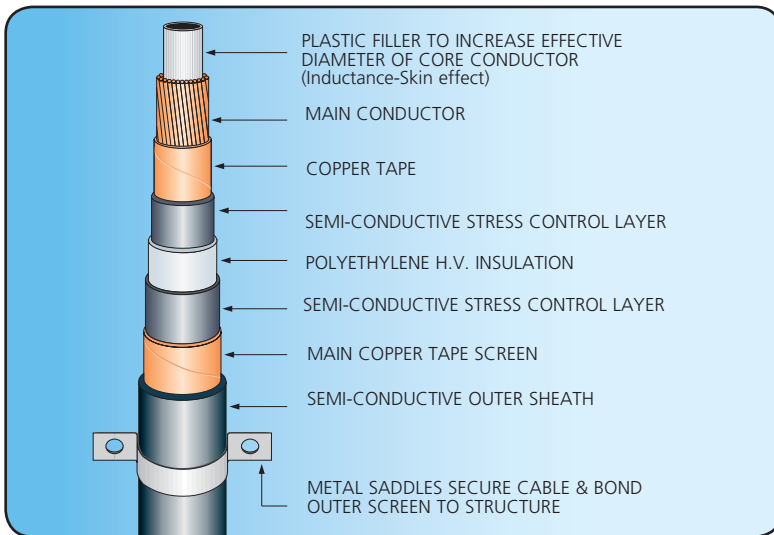

Technical and Design

Characteristics of ERICO ERICORE

The ERICO ERICORE downconductors have been designed to meet the criteria for an effective and reliable downconductor with the following key characteristics:

- A low inductance per unit length
- A low surge impedance
- A carefully controlled internal electric field distribution to minimise field stresses under current impulse conditions
- Carefully designed, stress reducing upper termination.

ERICO SYSTEM 1000



ERICO INTERCEPTOR SI ESE Lightning Terminals

- Designed and tested to NFC17-102 and UNE-21186
- Stainless steel design suitable for most environments
- Available in three models to suit specific site requirements
- Suitable for connection to a variety of downconductor systems including tape, cable, smooth-weave and ERICO ERICORE conductor
- Fully compatible with the ERICO SYSTEM 3000 mast, ERICO ERICORE cable and accessories

ERICO SYSTEM 2000

Conventional Protection

Conventional protection of buildings or structures involves the use of suitably positioned air terminals (lightning rods) which are interconnected with a metal downconductor network (usually copper) to provide the most direct path from the air termination to a low impedance grounding system.

This helps ensure a safe and effective dissipation of the lightning impulse. Comprehensive conventional systems are often referred to as Faraday Cages.

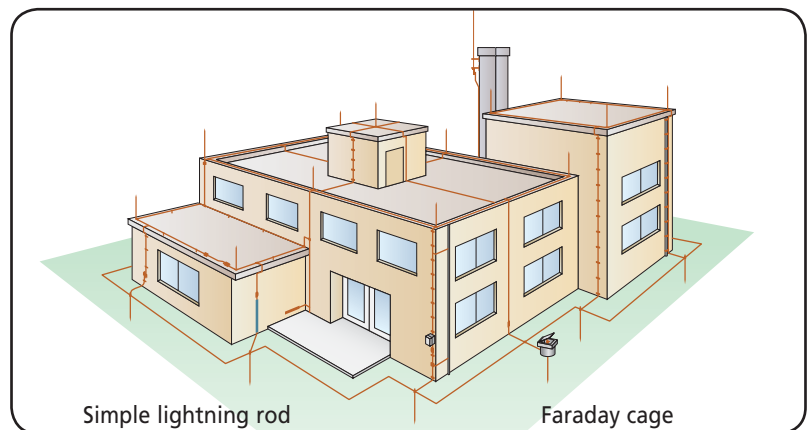

TECHNICAL INFORMATION

For the efficient performance of a lightning protection system, it is essential that a low impedance ground be provided to facilitate the dissipation of the lightning energy into the earth mass. Because soil conditions and seasonal patterns vary from site to site, the methods of grounding need to be considered on an individual basis.

Ground Rods, Tapes and Clamps

ERICO copper-bonded, galvanised and stainless steel earth rods facilitate the transfer of surges and fault currents into the earth, and provide a long service life due to superior construction and quality.

Ground enhancing materials can be applied around the conductors in a grounding system to reduce the local soil resistivity and lower ground impedance. They are particularly useful in areas of moisture variation, sandy soils and rocky ground.

Ground Potential Equalisation

Pentair's range of equipotential ground bars, plates, pre-engineered grids, and potential equalisation clamps combine to create a safe equipotential ground plane for the protection of personnel and equipment.

CADWELD/CADWELD PLUS Molecular Bonding

Connections are often the most critical element of grounding systems, and subsequently can become the weak point due to aging and corrosion. The preferred method of connection is the CADWELD exothermic welding process producing a molecular bond. The capacity of an earthing circuit to protect the safety of personnel depends on the quality of the connections made.

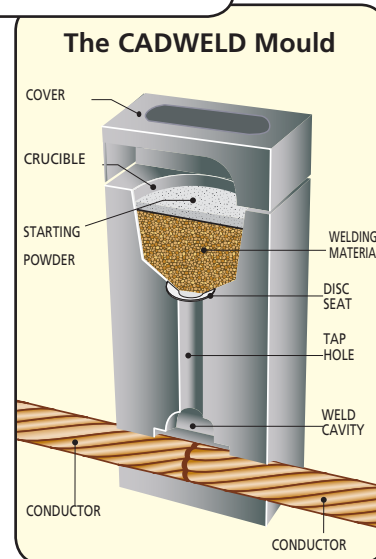
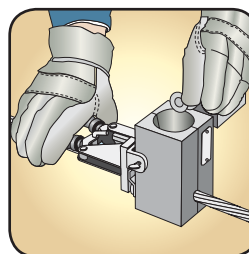
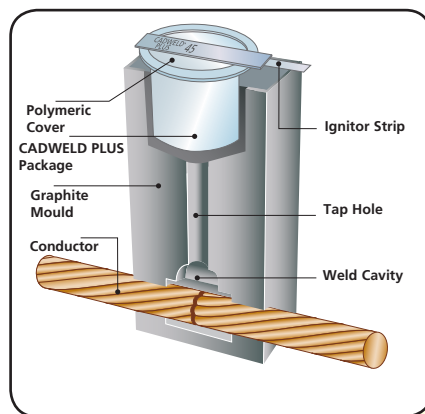
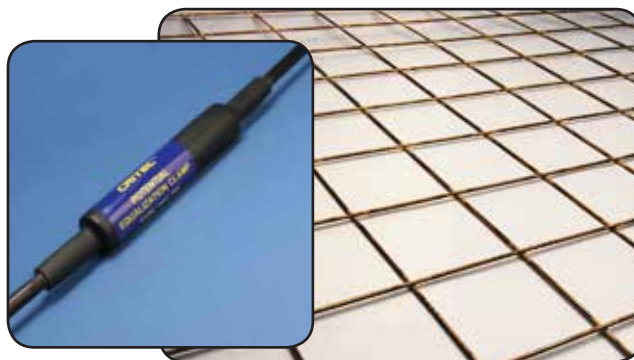

TECHNICAL INFORMATION

Ground Electrodes

The ground electrode is a critical component of the grounding system. Many different types of electrodes are available, some "natural" and some "made". The natural types include metal underground water pipe, the metal frame of a building (if effectively grounded), a copper wire or reinforcing bar in a concrete foundation or underground structures or systems. Consideration should be given to bonding of natural earths to ensure electrical continuity with a facilities' other "earths".

"Made" electrodes are specifically installed to improve the system grounding or earthing. These earth electrodes must ideally penetrate into the moisture level below the ground level to reduce resistance. They must also consist of metal conductors (or a combination of metal conductor types), which do not corrode excessively for the period of time they are expected to serve. Made electrodes include rods or pipes driven into the earth, metallic plates buried in the earth or a copper wire ring encircling the structure. Underground gas piping or aluminium electrodes are NOT permitted for use as ground electrodes.

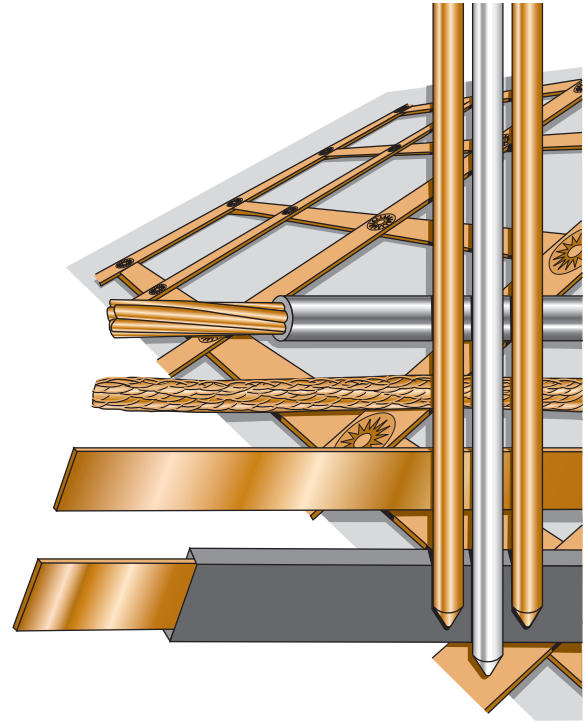

Ground rods are often selected on the basis of their resistance to corrosion. The other major factor is cost. All too often, the cost of a product is seen as the initial up front price, but the real cost is determined by the serviceable life of the ground rod.

Galvanised steel rods are one of the cheapest electrodes available. However, they are not the most cost effective since they have a relatively short service life. Solid copper and stainless steel rods have a long service life. However, they are considerably more expensive than galvanised steel rods. In addition to this, solid copper rods are not suited to deep driving or even driving short lengths into hard ground, without bending.

As a compromise, steel cored ground rods, swaged in a copper or stainless steel sheath were developed. These ground rods are much less expensive than their solid counterparts. They are capable of being deep driven. However, the sheath of this rod type has been known to slip or tear, particularly the copper version. Once this sheath has been damaged, the integrity of the entire electrode is at risk.

Ask for the Pentair White Paper on Ground Rods – Copper-bonded vs. Galvanised.

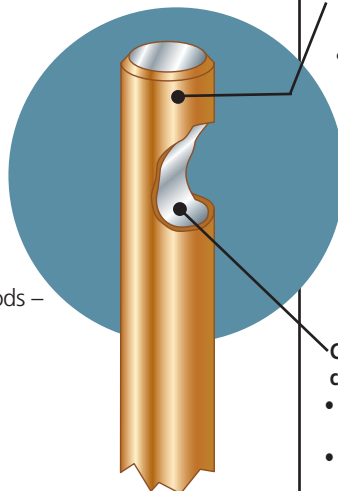

Copper-Bonded Ground Rod	Galvanised Ground Rod
<ul style="list-style-type: none"> • Cost effective long service life • Copper-bonded coating: <ul style="list-style-type: none"> • Permanent molecular bond • Low resistance performance • High fault current capacity (IEEE® Std 80) • Will not slip or tear when driven • Will not crack if rod is bent • Copper coating may vary to meet required standards • 10 mil (254 micron) minimum coating on rods listed to UL467 • Carbon Steel core and tip*: <ul style="list-style-type: none"> • Greater tensile strength • Deep driving capability 	<ul style="list-style-type: none"> • Lower purchase price — not as cost-effective over the expected life as Copper-bonded • Galvanised coating: <ul style="list-style-type: none"> • Relatively short service life • May crack if rod is bent • 3.9 mil (99 micron) minimum coating per ASTM® 123

* ERICO copper-bonded and galvanised rods

TECHNICAL INFORMATION

Ground Electrodes

The copper-bonded ground rod has an electrolytic coating of copper deposited over a layer of nickel. This process helps ensure a long lasting, molecular bond between the copper layer and the steel core. Pentair recommends copper-bonded ground rods because the copper coating will not slip or tear when driven nor will it crack if the rod is bent. The tough, carbon steel core has good characteristics for deep driving. Copper-bonded ground rods have a high resistance to corrosion and provide a low resistance path to ground.



Above photo shows two ground rods subjected to the same pressure load test. The ERICO copper-bonded ground rod, shown on the left, will bend without tears, cracks or folds, to the outer sheath. The inferior copperclad rod shown on the right, has developed cracks and creases to the outer sheath, which will significantly reduce its serviceable life and put the integrity of the entire electrode at risk.

The Stainless Steel Option

It is important to note that certain soils and land fill areas may not be compatible with copper. In these situations, stainless steel is a better proposition. Stainless steel may also be an alternative, where structures or components, such as steel towers, poles or lead sheathed cables are in close proximity to an array of ground electrodes. In these circumstances, consideration must be given to the consequence of galvanic corrosion. The high cost of stainless steel rods prohibits their widespread use.

Ground Rod Life Expectancy

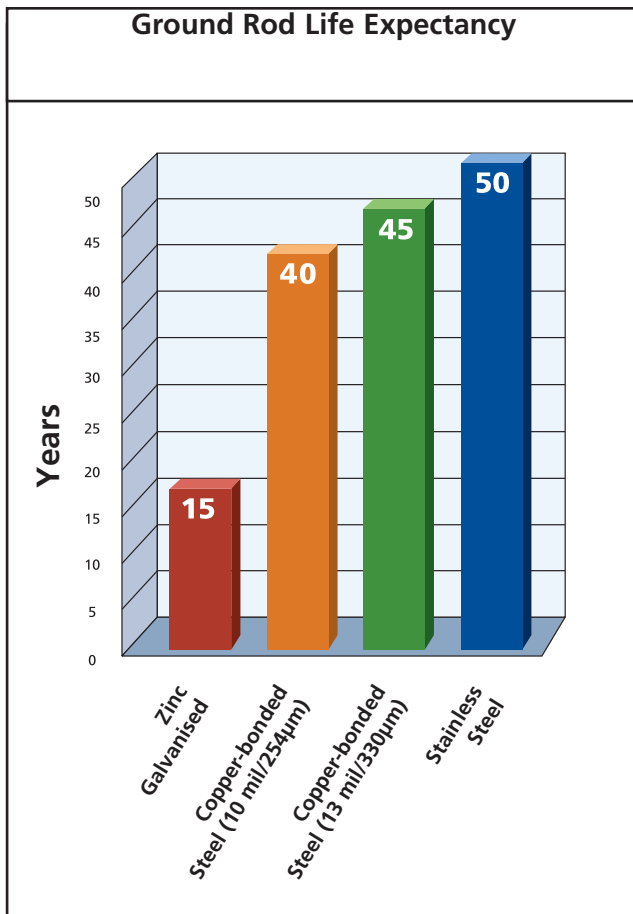

Ground Rod Annual Cost

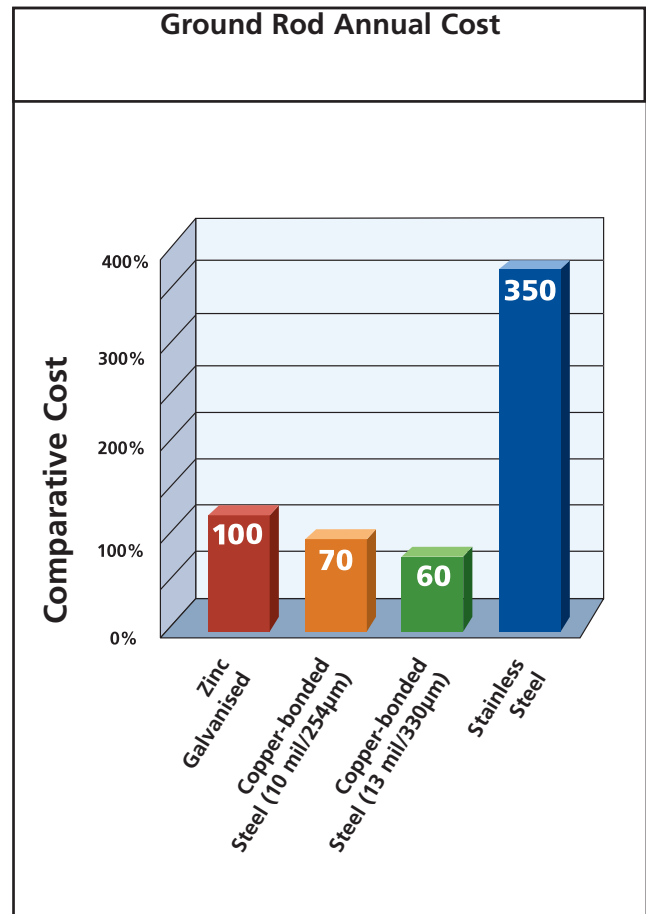

TECHNICAL INFORMATION

Main **copper-bonded ground rods and components** that are shown in the following pages are designed for quality and long lasting assemblies, as grounding electrodes.

They are **tested and certified to EN50164-series**, probably the most demanding testing programs existing nowadays. Testing took place recently, in an **accredited European Test-Lab** (RvA : Dutch Accreditation Council), working with **experienced scientific staff in close relationship with Pentair specialists**.

Testing on assemblies as well as on copper-bonded ground rod:

- Mechanical robustness
- Coating measurement
- Repetitive hammering

Note: Electrical testing after weeks in a corrosive salt spray environment are the main testing steps that were applied.

Detailed certificates and reports are available on demand.

Specimens before salt spray tests



Specimens after salt spray tests



Bending Test



Copper Adhesion Test



TECHNICAL INFORMATION

Why is Good Grounding Important?

The transient nature of lightning with its associated fast rise times and large magnitude currents mean that special consideration needs to be given to grounding, for lightning protection to be effective. Many factors such as soil resistivity variations, installation accessibility, layout and existing physical features are all site specific and tend to affect decisions on grounding methods employed. The primary aim of a direct strike grounding system is to:

- Efficiently dissipate lightning surge energy into the ground
- Help ensure safety of equipment and personnel

Grounding Principles

Low impedance is the key to lightning protection. All grounding connections should be as short and direct as possible to minimise inductance and reduce peak voltages induced in the connections. The ground electrode system must efficiently couple lightning surges into the ground by maximising capacitive coupling to the soil. The resistance of the ground itself to lightning currents must also be minimised. Only when all these factors are taken into account will maximum lightning protection be achieved.

Ground Impedance

Soil resistivity is an important design consideration. It varies markedly for different soil types, moisture content and temperatures and gives rise to variations in ground impedances.

Figure 1-B illustrates current flow from the injection point of a single ground electrode. As current flows out from the central injection point, a voltage gradient on the ground surface around the electrode is produced. This gradient levels off to a plateau at some distance from the electrode, as seen in Figure 1-A. The impedance seen by the current is determined by the soil particles in direct contact with the surface of the rod, and by the general impedance of the soil.

Short, Direct Ground Connections

The voltage generated by a lightning surge depends primarily on the risetime of the surge current and the impedance (primarily inductance) of the path to ground. Extremely fast rise times result in significant voltage rises due to any series inductance resulting from long, indirect paths, or sharp bends in the routing of ground conductors.

Couplings From the Electrode System to the Ground

The efficiency of a ground electrode system in coupling a lightning surge current to ground is dependent on a number of factors, including the geometry of the ground electrode system, the shape of the conductors and the effective coupling into the soil.

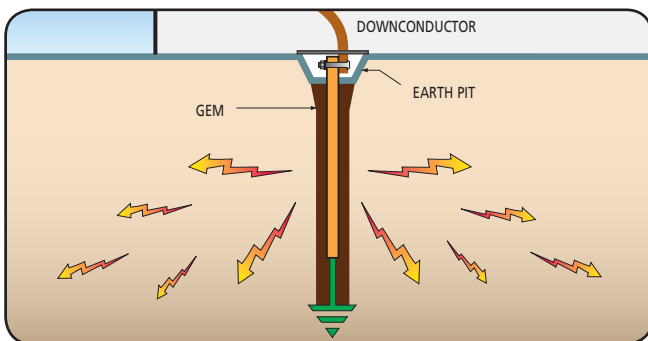

A typical grounding system.

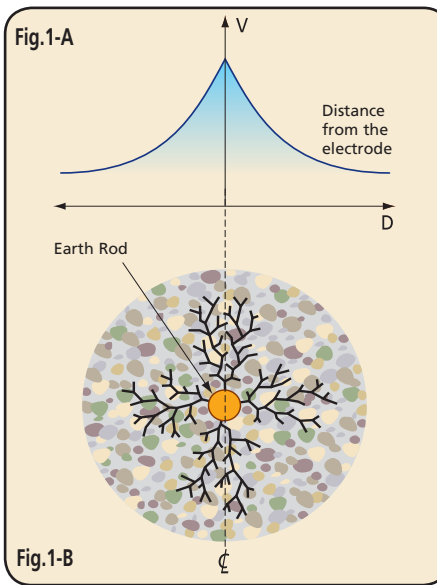

Characteristics of a Good Grounding System

- Good electrical conductivity
- Conductors capable of withstanding high fault currents
- Long life - at least 40 years
- Low ground resistance and impedance

The basis philosophy of any grounding installation should be an attempt to maximise the surface area of electrodes or conductors with the surrounding soil. Not only does this help to lower the earth resistance of the grounding system, but it also greatly improves the impedance of the grounding system under lightning surge conditions.

- Equipotential bonding

Equipotential bonding helps ensure that hazardous potential differences do not occur between different incoming conductors such as metallic water services, power systems, telecommunication systems and the local ground, and also minimises step and touch potentials.

- Good corrosion resistance

The ground electrode system should be corrosion resistant, and compatible with other conductors that are buried and bonded to the ground system. Copper is by far the most common material used for grounding conductors. In general, some form of maintenance or inspection procedure should be adopted to ensure the long-term effectiveness of a grounding system.

- Electrically and mechanically robust and reliable

Mechanical coupling can be used to join ground conductors, but suffers from corrosion effects when dissimilar metals are involved. As well as mechanical strength, CADWELD connections provide excellent low impedance, long life electrical connections with excellent corrosion resistance.

Component of a Grounding System

A grounding system for lightning protection serves to deliver the lightning current into ground. It consists of one or more ground electrodes (earthing rods) along with any interconnecting conductors. Components include:

- Ground rods
- Ground enhancing materials
- CADWELD exothermic welded connections
- Ground connectors – tapes, stranded cables, rod clamps, mesh, plates etc
- Ground pits - for access to the ground system

Designing a Ground Electrode System

A significant factor governing the choice of a grounding system are the applicable standards and codes:

European	IEC®/EN 62305-3, EN 50164 Series, EN 60364-54, NFC 17-102
American	NFPA® 780, IEEE® STD80, IEEE 837, NFPA 70
Australian	AS1768

Other factors to consider include:

- **The needs and layout of the facility**
(location and space confinement issues)
- **The ground environment of the facility itself**
(eg soil resistivity)
- **Existing grounding systems**
- **Susceptibility to seasonal variations in soil moisture content and temperature**
- **Exposure to pedestrian traffic**
- **Step and touch potentials**

While it is clear that a low impedance grounding system will allow the lightning surge energy to be dissipated into the ground, this will not necessarily minimise hazards to personnel in close proximity to the grounding system. High voltage gradients on the surface of the ground give rise to undesirable step and touch potential hazards. In order to reduce the chance of injury to personnel, both step and touch potentials must be minimised. Figure 2 graphically illustrates the danger of such potentials.

• Selecting the right connections

The connections between the conductors and the main grid, and between the grid and ground rods, are as important as the conductors themselves in maintaining a permanent low-resistance path to ground.

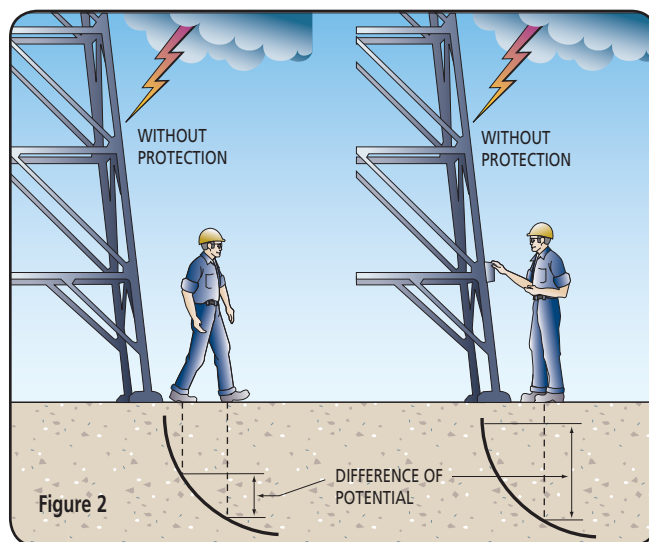

Step and Touch Potential. Step potential is the voltage difference between a person's feet caused by the dissipation gradient of a fault entering the earth. Touch potential is similar to "step potential" except that the fault current passes through the person's arm and torso on the way to the ground.

• Reducing ground impedance

Resistivity of the soil varies markedly for different soil types, moisture content and temperatures, and this gives rise to variations in ground system impedance. The lower the resistivity, the easier it is to achieve an effective grounding system. Measures that can be used for reducing earth impedance include:

- Connecting additional buried conductors to the ground electrode
- Use of multiple interconnected ground electrodes
- Use of flat tape rather than circular conductors
- Use of spaced conductors connected in parallel
- Use of equipotential mesh electrodes
- Use of multiple short interconnected buried conductor

• Use of ground enhancing compounds

Electrically conductive ground enhancing compounds can be applied to help lower ground resistance and impedance. They are particularly useful for rocky ground, areas of moisture variation and sandy soils. These compounds are generally applied around electrodes in oversized drill holes and around horizontal buried conductors.

• Use of mineral or chemical ground rods

Mineral or chemical ground rods are also used to decrease ground impedance. These consist of a perforated hollow copper tube sealed at the bottom. A salt compound is placed inside the tube which gradually leaches out to maintain a conductive environment around the electrode.

• Use of concrete slabs or footings

The use of reinforced concrete slabs and footings is one of the most effective ways to provide a low impedance ground electrode system. If addressed at the design stage this method can provide a very stable, permanent distributed ground electrode system at very little additional cost to the civil works.

TECHNICAL INFORMATION

Ground Potential Equalisation

Creating an equipotential earth plane under transient conditions is essential for equipment and personnel safety. However, separate earths are sometimes installed for lightning, mains power, computer and communications equipment in buildings and other installations. Although this may be desirable under normal operating conditions, when lightning or other transient voltages occur, potential differences between the separate earths are inevitable. These can enter buildings, destroying equipment and creating dangers for personnel.



The PEC (Potential Equalization Clamp) usually operates as an effective open circuit. However, once the earth potential difference exceeds the breakdown voltage of the PEC (under transient conditions), the circuit closes immediately and the earth potential's are equalised, thereby protecting equipment and people.

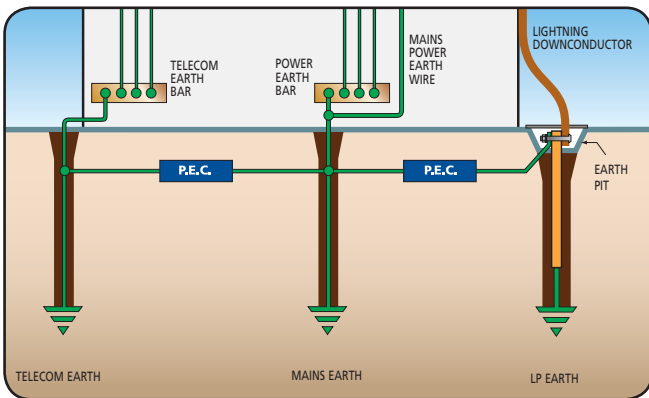

Equipotential earth plane created by bonding all earths together with Potential Equalization Clamps (PEC).

• Appropriate depth and separation of electrodes

The length, number and placement of ground rods affects the resistivity of the path to ground. The most cost-effective depth to which an electrode should be driven is usually dependent on specific soil conditions. Soils are rarely homogeneous or uniform and it may be advantageous to install electrodes to a particular depth where a low resistivity soil layer, such as a clay base, is encountered. Electrode depths commonly used are in the range of 1 to 4 m. Electrodes should be separated by a distance of at least twice the depth to which they are installed.

• Equipotential Bonding

Potential equalisation ensures that any potential rise due to the injection of lightning current into the impedance of the grounding network, is experienced by all the conductive services in the building. Thus everything rises in potential together and hazardous potential differences are avoided.



Ground Enhancement Material (GEM)

A superior conductive material that improves grounding effectiveness, especially in areas of poor conductivity (rocky ground, areas of moisture variation, sandy soils):

Estimated linear feet of ground conductor covering with each bag of GEM

Trench Width	Total thickness of GEM			
	2, 5 cm (1")	5, 1 cm (2")	7, 6 cm (3")	10, 2 cm (4")
10 cm (4")	4.3 m (14.0')	2.1 m (7.0')	1.4 m (4.7')	1.1 m (3.5')
15 cm (6")	2.8 m (9.3')	1.4 m (4.7')	0.9 m (3.1')	0.7 m (2.3')
20 cm (8")	2.1 m (7.0')	1.1 m (3.5')	0.7 m (2.3')	0.5 m (1.8')
25 cm (10")	1.7 m (5.6')	0.9 m (2.8')	0.6 m (1.9')	0.4 m (1.4')
30 cm (12")	1.4 m (4.7')	0.7 m (2.3')	0.5 m (1.6')	0.4 m (1.2')

Estimated bags of GEM for backfilling around ground rods to a density of 90 lb/cu ft (1442 kg/m3)

Dia. of hole	Depth of hole (Feet) *						
	1.8 m (6')	2.1 m (7')	2.4 m (8')	2.7 m (9')	5.2 m (17')	5.8 m (19')	6.1 m (20')
7.5 cm (3")	2	2	2	2	4	4	4
10.0 cm (4")	2	3	3	3	6	7	7
12.5 cm (5")	3	4	4	5	9	10	10
15.0 cm (6")	5	5	6	7	13	14	15
17.5 cm (7")	6	7	8	9	17	19	20
20.0 cm (8")	8	9	11	12	22	25	26
22.5 cm (9")	10	12	13	15	28	31	32
25.0 cm (10")	12	14	16	18	34	38	40

Protection From Power Surges

To meet the fundamental requirements of performance, longer service life and greater safety under real world conditions, Pentair has developed a range of technologies covering all aspects of the Six Point Plan of Protection. In the field of surge protection, several technologies play a critical role in the provision of premium performance.

The DINLINE Product range offers both shunt or series protection utilising differing technologies in compact DIN rail mounted products. A number of different options are available to suit your individual application or performance requirements.

Shunt Surge Protection Devices



The DINLINE Surge Diverters (DSD) offer economical and reliable protection from transients on power lines with the convenience of easy installation on 35 mm DIN rail mountings.

The DSD range includes the three phase DSD340 series for simple installation into TN-C, TN-S and TT systems. Alternatively multiple DSD1x units may be configured for TN-C, TN-S, TN-C-S, TT & IT systems with surge ratings ranging from 10kA to 150kA.

Internal thermal disconnect devices ensure safe isolation during sustained and abnormal events on the distribution network. Most units feature visual indication in the event of such operation. In addition, select units are available with voltage-free contacts for remote signaling if replacement is due.

Protection of Communications Equipment

Transients and surges caused by lightning, or switching of power equipment, affect communications signals carried on copper cables. Telecommunications lines, industrial process control, coaxial feeders and computer networks are all vulnerable to surges, which may be up to 20kA for some high-risk environments. In the field of communications surge protection, several product variations are required to ensure all applications are met. Therefore Pentair offers protection products to meet a wide variety of applications, from telecommunication line protectors for either KRONE® or DIN connection to coaxial surge protectors suitable for either BNC or N type coax cables.

The various product families and applications are summarised below:

Subscriber Line Protection (SLP) and High Speed Digital Protection (HSP) Product family

- High 20kA (8/20us) surge rating
- KRONE LSA-Plus Termination
- Both Single Stage and Multi-Stage models available

Universal Transient Barrier (UTB)

- High 20kA (8/20us) surge rating
- Premium three stage protection
- Self-resetting, over-voltage and over-current protection

Co-axial Surge Protectors (CSP)

- Robust, plug-in style design
- Range of connections types and operating voltages available
- Wide operating frequency from DC up to 3GHz

Data Line Protectors (DLP) / Data Equipment Protectors (DEP) / Local Area Network Protectors (LAN)

- Range of connections types available, from DB to RJ45 and KRONE
- Wide range of operating voltages and frequencies available
- Surge Ratings from 500A to 20kA depending on product and application

TECHNICAL INFORMATION

Transient Discriminating Technology

To meet the fundamental requirements of performance, longer service life and greater safety under real world conditions, ERICO has developed Transient Discriminating (TD) Technology.

This quantum leap in technology adds a level of "intelligence" to the Surge Protection Device (SPD) enabling it to discriminate between sustained abnormal over-voltage conditions and true transient or surge events. Not only does this help ensure safe operation under practical application, but it also prolongs the life of the protector since permanent disconnects are not required as a means of achieving internal over-voltage protection.

Traditional Technologies

Conventional SPD technologies utilize metal oxide varistors and/or silicon avalanche diodes to clamp or limit transient events. However, these devices are susceptible to sustained 50/60Hz mains over-voltage conditions which often occur during faults to the utility system. Such occurrences present a significant safety hazard when the suppression device attempts to clamp the peak of each half cycle on the mains over-voltage. This condition can cause the device to rapidly accumulate heat and in turn fail with the possibility of inducing a fire hazard.

The Core of TD Technology

The secret to ERICO's Transient Discriminating Technology is its active frequency discrimination circuit. This patented device can discriminate between a temporary over-voltage (TOV) condition and a very fast transient,

which is associated with lightning or switching-induced surges. When the transient frequencies are detected, the patented Quick-Switch within TD activates to allow the robust protection to limit the incoming transient. The frequency discriminating circuit that controls the Quick-Switch helps ensure that the SPD is immune to the effects of a sustained 50 or 60Hz TOV. This allows the device to keep operating, in order to help provide safe and reliable transient protection, even after an abnormal over-voltage condition has occurred.

Meeting & Exceeding UL Standards

Surge protection devices from ERICO employing TD Technology have been specifically designed to meet and exceed the new safety requirements of UL 1449 Edition 3. To meet the abnormal over-voltage testing of UL 1449 Edition 3, many manufacturers of SPDs have incorporated fuse or thermal disconnect devices which permanently disconnect all protection from the circuit during an over-voltage event. Transient Discriminating Technology on the other hand will allow the SPD to experience an abnormal over-voltage up to twice its nominal operating voltage and still remain operational even after this event! This allows the device to help provide safe, reliable and continuous protection to your sensitive electronic equipment. TD Technology is especially recommended for any site where sustained over-voltages are known to occur, and where failure of traditional SPD technologies cannot be tolerated.

The UL 1449 testing standard addresses the safety of an SPD under temporary and abnormal overvoltage conditions, but does not specifically mandate a design that will give a reliable, long length of service in the real world. Specifically, UL 1449 tests that the SPD remains operational at 10% above nominal supply voltage, allowing SPD manufacturers to design products that permanently disconnect just above that. Most reputable manufacturer's designs allow for up to a 25% overvoltage, while ERICO's TD Technology gives even greater overhead.

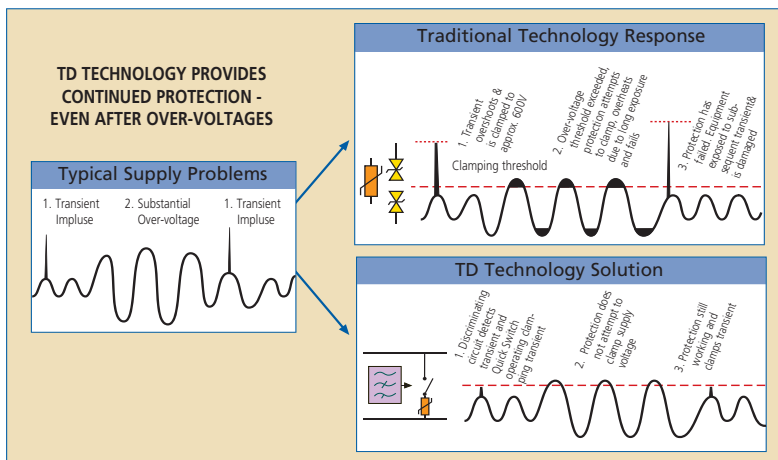
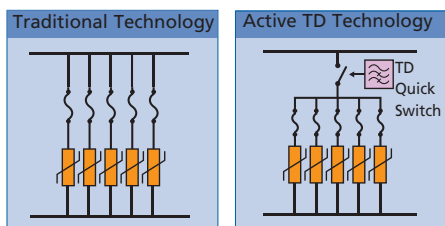

CADWELD/CADWELD PLUS The Molecular Bond

CADWELD Exothermic Connection

A welding process that eliminates the connection by forming a molecular bond.

Connections are the weak point of all electrical circuits and especially earthing circuits subjected to aging and corrosion. The capacity of an earthing circuit to protect the safety of personnel depends on the quality of the connections made.

The CADWELD Process

The CADWELD process provides a way to produce copper/copper, copper/galvanised or plain steel, copper/copper clad steel, copper/bronze/brass/stainless steel, steel/steel, molecular bonds with no external energy or heat source.

The principle consists of bringing together a welding filler material and ignition agent in a suitable graphite mould.

The reduction of copper oxide by aluminium produces molten copper and aluminium oxide slag at extremely high temperatures.

The shape of the mould, its dimensions, and the size of the weldmetal, are all dependent on the items to be welded and their size.

The CADWELD Mould Using CADWELD PLUS

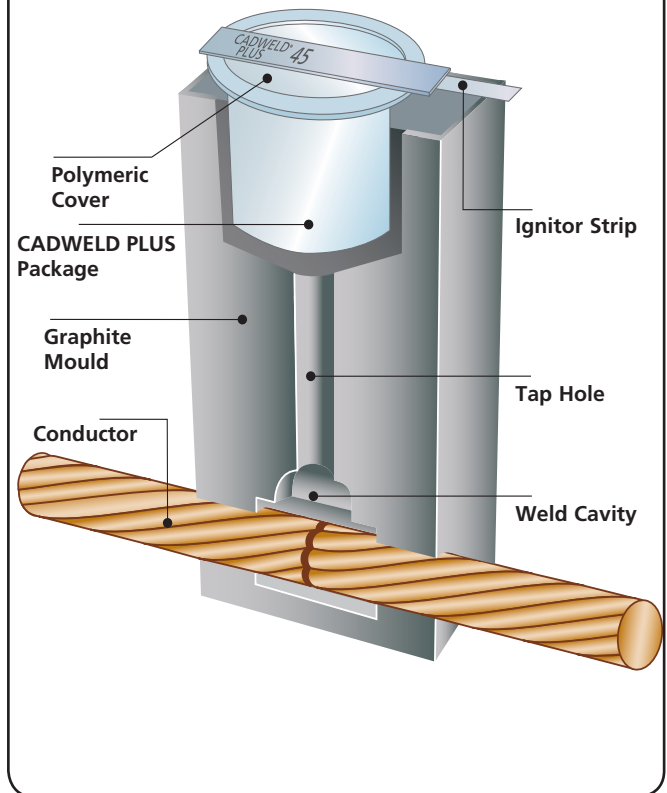

Installation Is Easy!

4 Very Simple Steps For Permanently Welded Electrical Connections

CADWELD PLUS Control Unit initiates the reaction of the metal crucible. The standard unit includes a 6-foot (1.8 meter) high temperature control unit lead. The lead attaches to the ignition strip using a custom made, purpose-designed termination clip.

After the termination clip is installed on the ignition strip, the installer pushes and holds the ignition button to start a charging and discharging sequence. Within a few seconds the control unit sends a predetermined voltage to the ignition strip and the reaction is initiated.



1 Insert CADWELD PLUS package into mould



2 Attach control unit termination clip to ignition strip



3 Press and hold control unit switch and wait for the ignition



4 Open the mould and remove the expended steel cup – no special disposal required

TECHNICAL INFORMATION

The CADWELD Weld

- Will carry more current than the conductor.
- Will not deteriorate with age.
- Is a molecular bond that eliminates any risk of loosening or corrosion.
- Will resist repeated fault currents.
- Can be quality controlled simply by visual inspection.

Reliability

As the molecular bond eliminates the concept of surface contact, an electrolyte cannot penetrate between the conductors and cause oxidation and deterioration in the course of time.

Corrosive Environments

This reliability is of particular interest for humid or chemical environments or for bonds directly buried in the ground.

Ability to Withstand High Current

The melting temperature of CADWELD filler material is higher than the melting temperature of copper (1082°C). For this reason, in the event of abnormal heating due to a high fault current, the conductor is destroyed before the connection.

Conductivity

The CADWELD connections form a solid bond around the conductors assuring continuity. The cross sectional area of the weld has greater current carrying capacity than the conductors.

Performance

Standard CADWELD welds have a cross section greater than that of the conductors to be joined, which compensates for the difference in resistivity between the conductor and the welding material. Consequently, under fault conditions the weld will always remain cooler than the conductor.

If special applications do not allow for the required increase in cross section to be employed, the use of the formula:

$$R = \frac{\rho \times l}{S} \text{ and } V = R \times I$$

will make it possible to define precisely the resistance of the CADWELD weld.

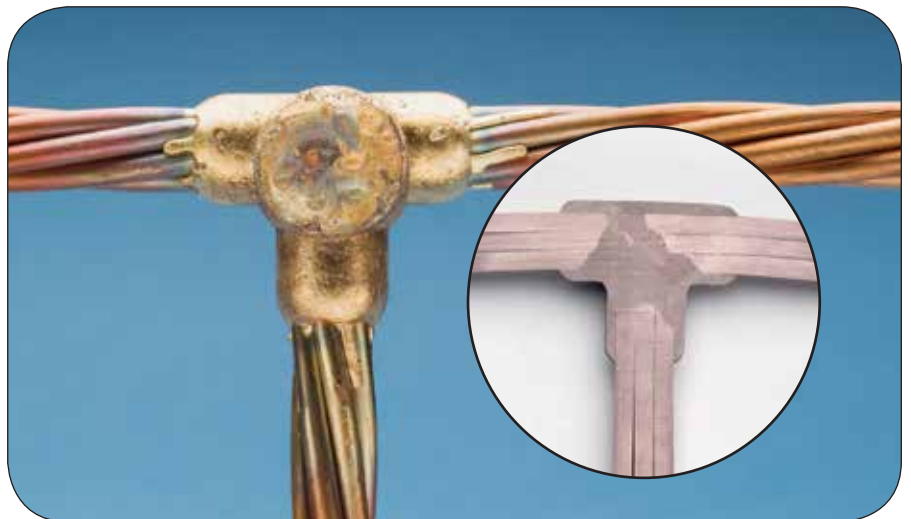

Corrosion Test

This accelerated aging test, carried out in a saline atmosphere at a controlled temperature, demonstrates that CADWELD welds retain all their electrical properties during the period of the test whereas the resistance of mechanical connections increase with time and this alters their conductive properties.

CADWELD'S fine performance is due to its reliability resulting from the molecular bond.

Comparison between CADWELD bonded connection and mechanical connection CADWELD weld (Metal A) (Metal B).

The CADWELD bonded connection provides permanent conductivity over the whole of the section due to molecular bonding between the metal surfaces.

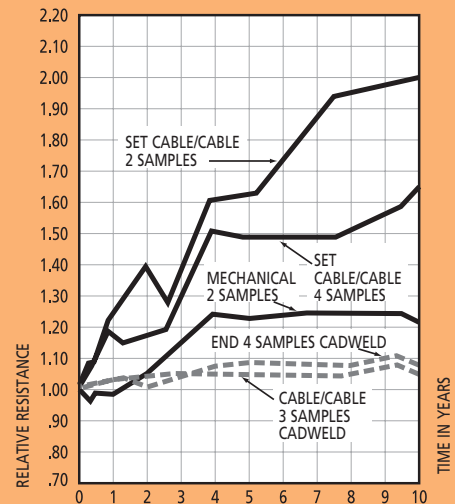

Comparison between CADWELD Bonded Connection and Mechanical Connection

CADWELD Weld

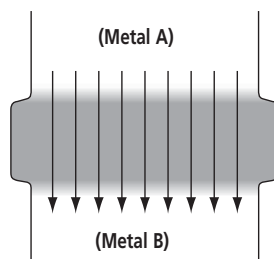

The CADWELD bonded connection provides permanent conductivity over the whole of the section due to molecular bonding between the metal surfaces.

Mechanical Crimped Connection

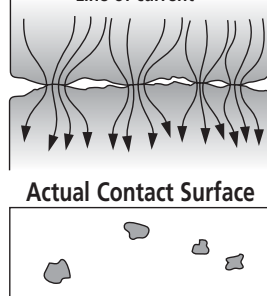

The mechanical connection presents a significant difference between the apparent contact surface and the actual surface.

ERICO SYSTEM 3000

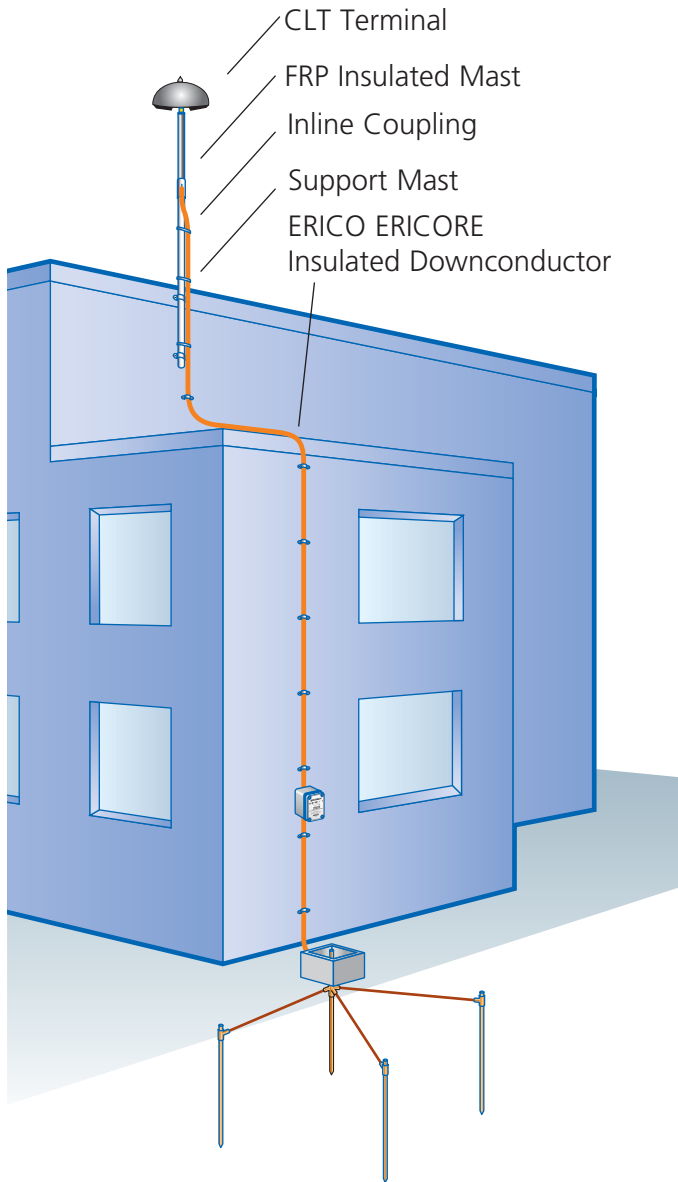

The ERICO SYSTEM 3000 is a technically advanced lightning protection system. The ERICO DYNASPHERE air terminal provides a preferred point for lightning discharges which would otherwise strike and damage an unprotected structure and/or its contents. The ERICO DYNASPHERE is connected to a single insulated downconductor (ERICO ERICORE) and the ground system in such a way as to provide a totally integrated system.

ERICO SYSTEM 1000

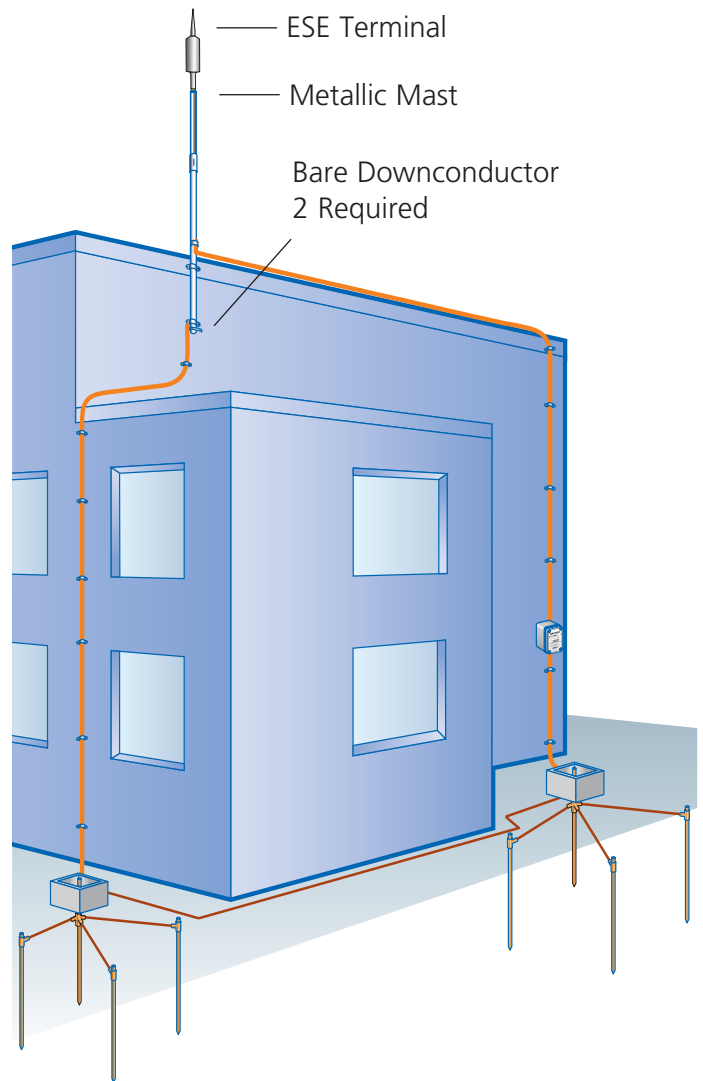

The ERICO SYSTEM 1000 SI Interceptor terminal is designed and tested to the French standard NFC17-102 and Spanish norm UNE-21186. The standards provide simple placement rules and determination of the protected area.

The terminals are erected with conductive masts and connected to the ground with two downconductors running on opposite walls.

LIGHTNING PROTECTION

ERICO SYSTEM 3000

ERICO DYNASPHERE Air Terminal



Reference code	Part No.	Description	Unit weight kg
D/SMKIVSS	702085	ERICO DYNASPHERE	5
INTMKIVSS	702089	ERICO INTERCEPTOR	2

ERICO ERICORE Downconductors

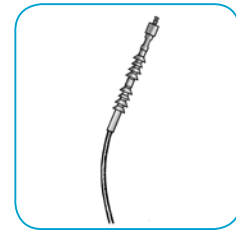
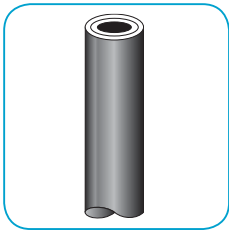

Reference code	Part No.	Section	Unit weight kg
ERICORE/PER M	701875	50 mm ²	1,2 per meter

Reference code	Part No.	Description	Unit weight kg
••• Terminations			
ERICORE/TRM/OS	701915	Factory Upper Termination, outside drum	1,5
ERICORE/TRM/IS	701895	Factory Upper Termination, inside drum	1,5
ERICORE/LT KITA	702005	Lower Termination	1,5

Insulated Masts

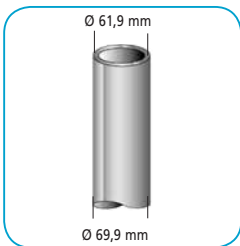

Reference code	Part No.	Colour	Length (mm)	Unit weight kg
••• Fiberglass reinforced				
FRP/2M/BLACK	702030	Black	2000	5
FRP/4.6M/BLACK	702045	Black	4600	11,5

Inline Coupling

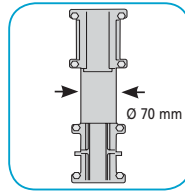

Reference code	Part No.	Unit weight kg
I/COUPL	701320	10,5

Aluminium Masts

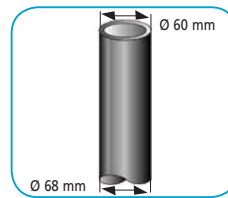

Reference code	Part No.	Length (mm)	Unit weight kg
ALUM 3ME	502000	3000	8,25
ALUM 4M	701370	4000	11
ALUM 5M	701380	5000	13
ALUM 6M	701390	6000	16

Aluminium Masts & Bases

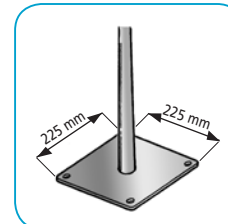

Reference code	Part No.	Length (mm)	Unit weight kg
••• Aluminium			
MBMAST3ME	502040	3000	9,6
MBMAST4M	701340	4000	12
MBMAST5M	701350	5000	15
MBMAST6M	701360	6000	17

Mast Brackets

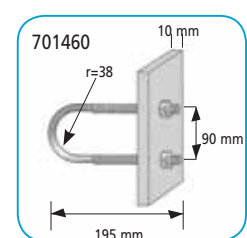
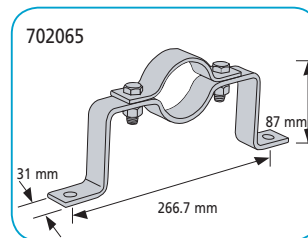

Reference code	Part No.	Description	Unit weight kg
700025054	702065	Stainless steel mast bracket	1,12
UBOLT	701460	Pair of UBOLTS	0,4

LIGHTNING PROTECTION

ERICO DYNASPHERE/ ERICO INTERCEPTOR SI Adaptors

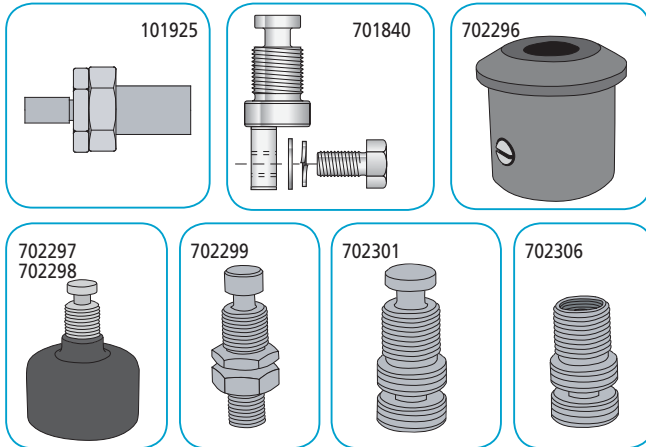

Reference code	Part No.	Description		Unit weight kg
ER1ARCCSS	101925	Adaptor to fix ARC to ER1-xxxx-SS*	1	0,1
THERMLUGCOUPL	701840	For bare downconductor	1	0,1
INTCPTADBUTT	702296	For SI terminal to FRP	1	0,05
INTCPTADF2BSPF	702297	SI terminal to 2" pipe. British thread	1	0,1
INTCPTADF2NSP	702298	SI terminal to 2" pipe. USA thread	1	0,1
INTCPTADM3/4UNC	702299	SI terminal to 3/4" pipe. USA thread	1	0,1
INTCPTADM116UN	702301	SI terminal to ER2-xxxx-SS*	1	0,1
INTCPTADM16	702306	16mm Conventional Rod to ER2-xxxx-SS*	1	0,1

* See ERICO INTERCEPTOR SI Masts

Guy Ring

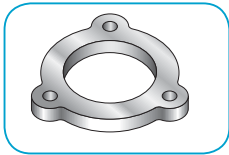

Reference code	Part No.	ø mm			Unit weight kg
		in	out		
••• Aluminium					
GUYRING	701280	60	91	1	0,11

Guy Kit

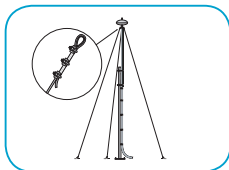

Reference code	Part No.	Description		Unit weight kg
GUYKIT 4MGRIP	701305	4m vertical guy	1	0,400
GUYKIT 7MGRIP	701315	7m vertical guy	1	0,700

ERICO ERICORE Fixings



Reference code	Part No.		Unit weight kg
CONSAD/E2	701990	5	0,19
CONSAD/FX	701410	100	0,01
CABTIESS	701420	1	0,05

Lightning Event Counter



Reference code	Part No.		Unit weight kg
LECIV	702050	1	2

ERICO SYSTEM 1000

ERICO INTERCEPTOR SI Air Terminals



Reference code	Part No.	Description		Unit weight kg
SI25	701535	ESE, 25µs	1	3
SI40	701536	ESE, 40µs	1	3
SI60	701537	ESE, 60µs	1	3

ERICO INTERCEPTOR SI Masts

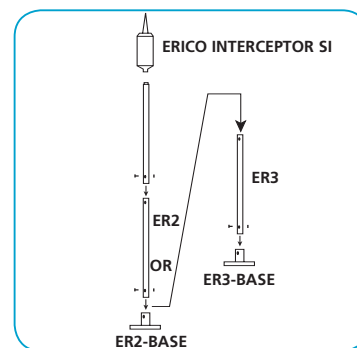

Reference code	Part No.	Description		Unit weight kg
••• Stainless Steel				
ER11000SS	702255	Upper Section, 1m	1	3,5
ER12000SS	702260	Upper Section, 2m	1	6,2
ER22000SS	702265	Mid Section, 2m	1	4,9
ER23000SS	702270	Mid Section, 3m	1	7,3
ER2BASE	702290	Base for ER2 mast	1	5,2
ER32000SS	702275	Lower Section, 2m	1	5,3
ER33000SS	702280	Lower Section, 3m	1	7,9
ER3BASE	702295	Base for ER3 mast	1	5,6

ISOLATED DOWNCONDUCTOR SYSTEM

LIGHTNING PROTECTION

Since ERICO offered its first isolated downconductor, thousands of building owners have implemented this concept. The pioneering use of semi-conductive external outer sheath to bond to the structure and control cable break down was a key to success. The original implementation (ERICO ERICORE) was a screened cable version designed for low impedance, this allowed the use of very long cable lengths. The latest ERICO isolated downconductor customizes this development by offering a lower cost cable targeted at the typical shorter installation requirements of the telecommunication industry. The cable is designed, tested and applied to meet the requirements of IEC 62305 lightning protection standards.

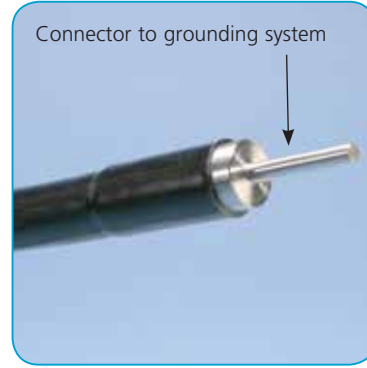
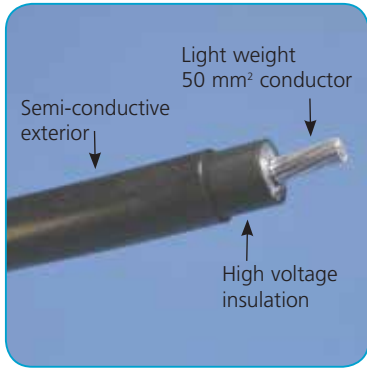

ERICO isolated downconductor low cast cable

What is the ERICO isolated downconductor system?

The ERICO isolated system provides a traditional air terminal fitted to an isolated fiberglass reinforced plastic (FRP) mast. The isolated downconductor internally connects to the air terminal inside the FRP. The FRP mast has natural isolation properties, high strength for windy sites and low weight to minimise mast loading.

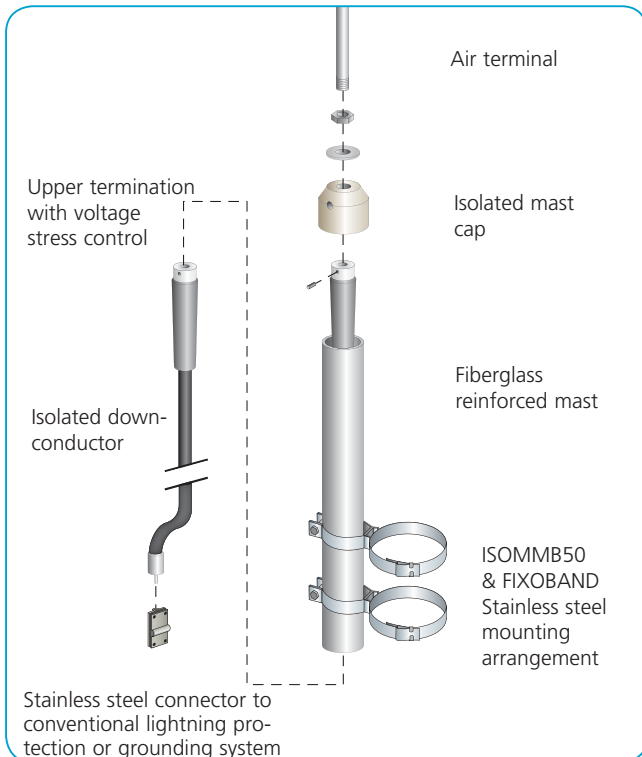

ERICO isolated downconductor



ERICO isolated system

Sample list of ISODC parts available. Contact Pentair for more information.

Reference code*	Part No.*
ISODC01	705001
ISODC02	705002
ISODC03	705003
ISODC04	705004
ISODC05	705005
ISODC10	705010
ISODC15	705015
ISODC20	705020
ISODC30	705030
ISODC40	705040
ISODC50	705050

* The last 2 numbers represent the length of conductor in meters, i.e. ISODC01 is 1 meter long.

ISOLATED DOWNCONDUCTOR SYSTEM



Air Terminal
 AAR0515 (#710020) 500 mm 0.25 kg
 AAR1015 (#711070) 1000 mm 0.53kg

Aluminium air terminal, 16 mm diameter.



Cable Tie
 CABTIESS (#701420)
 Stainless Steel Cable Tie 0.05 kg

520 mm stainless steel cable tie for securing downconductor.



Isolated Mast Cap
 ISOCAP50 (#702086) 0.1 kg

Fits to top of ISOFRP3M mast for mounting of air terminal.

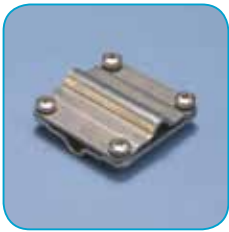

Multipurpose Clamp
 CCS308 (#545170) Stainless Steel Clamp 0.15 kg

For connection of lower termination to 25x3 mm, 30x2 mm or 8-10 mm diameter lightning protection or grounding systems.

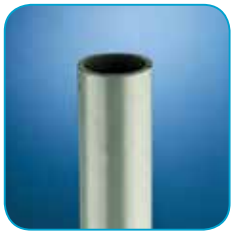

Isolated Mast
 ISOFRP3M (#702087) 4.2 kg

3 m fiber glass mast, 50 mm diameter.



Lightning Event Counter
 LECIV (#702050) Lightning Event Counter 2.0 kg

Installed upon downconductor to record number of lightning strikes.



Isolated Mast Bracket
 ISOMMB50 (#702088) 0.4 kg

For mounting ISOFRP3M. Use 20 mm stainless steel Fixoband to allow mounting on virtually any mast type/diameter.



Mast Bracket
 ALOF1-GS (#702175) 1.5 kg Galvanised mast bracket providing 190 mm offset.

ACF2-GS (#103100) 2.1 kg Galvanised x mast bracket



Isolated Downconductor
 ISODC 0.58 kg/m

Supplied with factory upper termination fitted and materials for customer lower termination. Order required length in meters. Available length on page 20.



Dual Downconductor Adaptor
 ISODUAL (#702094) 0.2 kg
 For connecting second parallel ISODC for increased safety distance.



Cable Saddle and Screws
 2HPS (#400680) Saddle 0.02 kg
 CONSAD/FX (#701410) Screw 0.01kg

Galvanised steel cable saddle and stainless steel screws for securing ISODC.



42014 (#591290) Fixoband Tool 1.8 kg

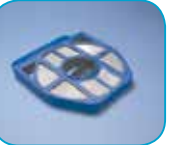

FEI20 (#591230) Stainless Steel Strap 20 mm 0.1 kg



CEI20 (#591080) Stainless Steel Buckle 0.01 kg

Strapping materials and tools for installation of mast mounting bracket ISOMMB50.

Pentair offers a large range of products for lightning and grounding applications. Please contact us should you require additional materials.

LIGHTNING PROTECTION

ERICO SYSTEM 2000

LIGHTNING PROTECTION



The ERICO SYSTEM 2000 lightning protection system is comprised of these principal components:

- Air termination network
- Downconductors
- Grounding system
- Bonding

This illustration is not drawn to scale, nor does it portray an actual or typical application. It is designed to illustrate some of the major components of the ERICO SYSTEM 2000 Lightning Protection System and their relationship with one another.

Air terminal placement is designed using the computer aided design to EN 62305-3, AS 1768, NFPA 780. This ensures the most effective placement of air terminations on the structure. Downconductors are positioned to provide the most direct path from the air termination to a low impedance grounding system, to help ensure safe and effective dissipation of the lightning impulse. Equipotential bonding of all circuits and conductors is necessary to reduce ground potential differences and to limit equipotential damage.

LIGHTNING PROTECTION

Air Terminals



Reference code	Part No.	ø mm	L mm		Unit weight kg
••• Copper					
CAR0510	711080	10	500	1	0,480
CAR0515	711090	16	500	1	0,750
CAR1010	711100	10	1000	1	1,100
CAR1015	711110	16	1000	1	1,510
CAR2015	711010	16	2000	1	3,000
••• Aluminium					
AAR0510	711050	10	500	1	0,190
AAR1010	711060	10	1000	1	0,380
AAR0515	710020	16	500	1	0,265
AAR1015	711070	16	1000	1	0,530

Multiple Point Air Terminal

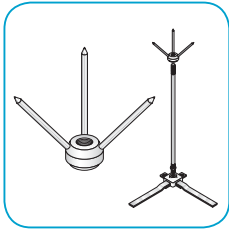

Reference code	Part No.	ø mm	L mm		Unit weight kg
CMPR	711120	16	500	1	1,200

Air Terminals Bases

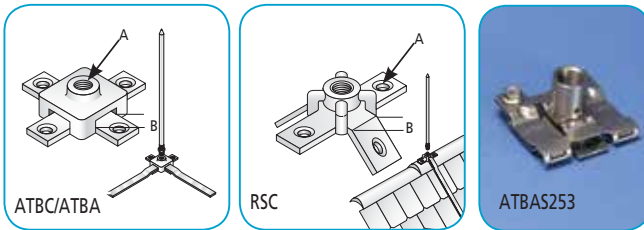

Reference code	Part No.	A mm	B mm		Unit weight kg
••• Aluminium					
ATBC10	711150	10	25	1	0,500
ATBC15	711160	16	25	1	0,500
ATBCS253	ATBCS253	10 & 16	26	1	0,134
RSC115	711170	16	31	1	1,700
••• Aluminium					
ATBA10	711130	10	25	1	0,160
ATBA15	711140	16	25	1	0,160
ATBAS253	ATBAS253	10 & 16	26	1	0,094
••• Stainless steel					
ATBSS253	ATBSS253	10 & 16	26	1	0,126

Air Terminal to Tape Coupling/Brackets

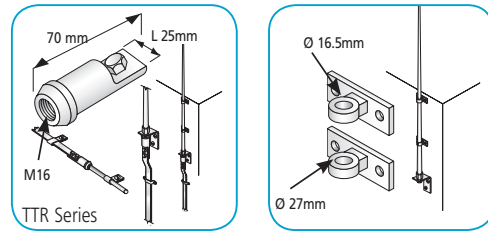

Reference code	Part No.	Material		Unit weight kg
TTRC16	711210	Copper	1	0,230
TTRA16	711200	Aluminium	1	0,080
••• Rod brackets				
CBR015	711190	Copper	2	0,900
ABR015	711180	Aluminium	2	0,280

Simple Air Terminal

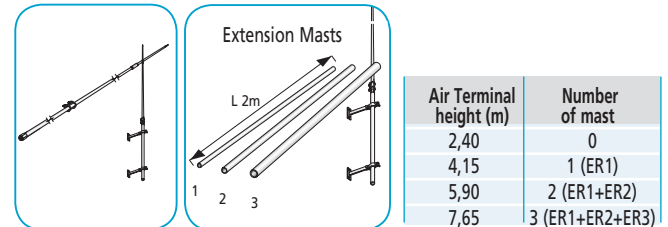

Air Terminal height (m)	Number of mast
2,40	0
4,15	1 (ER1)
5,90	2 (ER1+ER2)
7,65	3 (ER1+ER2+ER3)

Reference code	Part No.	Material	Length (m)	ø mm		Unit weight kg
••• Chrome - nickel plated copper						
ASL240CC	101700	2,40 m	30	1	3,750	
••• Galvanised steel extension masts						
ER12000	101920	12	33	1	13,800	
ER22000	101930	22	36	1	14,200	
ER32000	101940	32	42	1	15,000	

Tripod For Mast or Simple Air Terminal

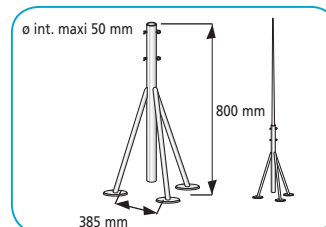

Reference code	Part No.	Nr of masts		Unit weight kg
••• Galvanised steel				
TF5 800	101950	0-3	1	8,280

LIGHTNING PROTECTION

Waterproof Cone/Aerial Spark Gap

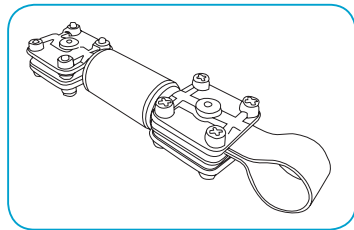
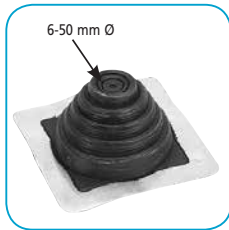

Reference code	Part No.		Unit weight kg
WPC	702230	1	0,070
SGAERIAL302	702285	1	0,500

Set of Two 54 cm Brackets

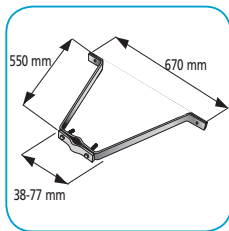

Reference code	Part No.		Unit weight kg
LSEB 4554	702180	1 pair	10,5

Brackets For Mast or Air Terminal

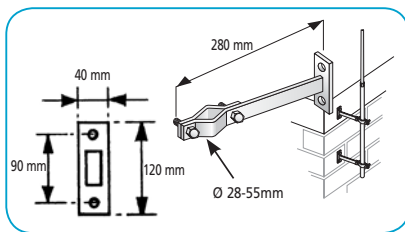

Reference code	Part No.		Unit weight kg
••• Galvanised steel			
ALOF1GS	702175	1	1,500

X-Shaped Bracket



Reference code	Part No.	Description	Admissible ø mm		Unit weight kg
ACF2GS	103100	Set of 2 Fasteners	30 to 50	1	2,10

Striking Rods

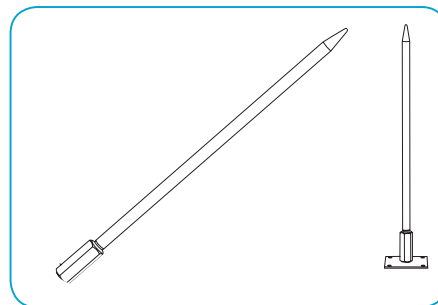

Reference code	Part No.	Lightning rod height		Unit weight kg
ARC2205CNC	101900	0,50m	1	0,550
ARC2210CNC	101910	1m	1	0,800
ARC2205SS	102000	0.50m	1	0,500
ARC2210SS	102010	1m	1	0,750

Air Terminal Bases and Fasteners

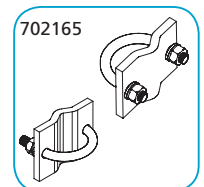
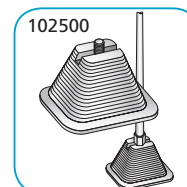
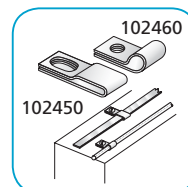
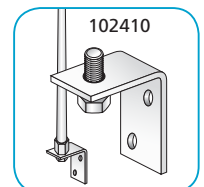
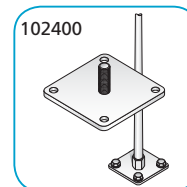
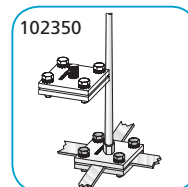

Reference code	Part No.	Description		Unit weight kg
ASBTCA	102350	Base rod support and cross-over	1	0,250
ASP100TS	102400	Support plate	1	0,430
ASATB	102410	Angle support plate	1	0,200
ABFF6530TC	102450	For flat conductor (30x2)	1	0,070
ABFR6530TC	102460	For round conductor (8mm)	1	0,050
ASFRC	102500	Cement block support	10	1,000
TMCSS	702165	Tape to Mast Clamp	1	0,200

LIGHTNING PROTECTION

Fasteners For Air Terminal

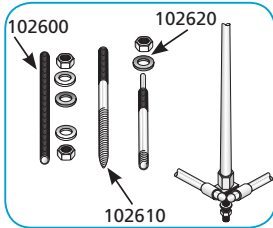

Reference code	Part No.	Description		Unit weight kg
ATR10SS	102600	M10 threaded rod, 100 mm long	10	0,080
ACB10SS	102610	Supporting anchor bolt* Angle support plate	10	0,060
AEM10SS	102620	Expanding support pin, M10 85 mm long, drilling depth 60 mm	10	0,040

*Supplied with impermeable collar

Puddle Flanges

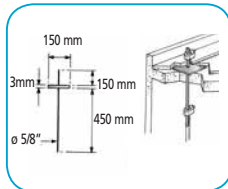
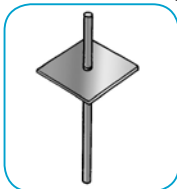

Reference code	Part No.	Material		Unit weight kg
PFC001	710290	Copper	1	-
PFA001	710295	Aluminium	1	-

DC Tape Clips

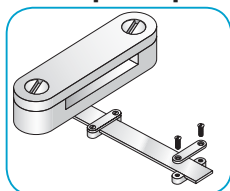

Minimum Order Required

Reference code	Part No.	Description		Unit weight kg
••• Copper				
DCC253	711220	for 25x3 bare copper tape	50	0,070
DCC256	711230	for 25x6 bare copper tape	50	0,080
DCC316	711660	for 31x6 bare copper tape	25	0,090
DCC506	711240	for 50x6 bare copper tape	25	0,160
DCC600	711250	for 25x3 PVC covered Cu tape	50	0,100
DCC605	711260	for 25x6 PVC covered Cu tape	50	0,130
DCC610	711270	for 50x6 PVC covered Cu tape	25	0,260
DCCS253	DCCS253	26x3	50	0,034
••• Aluminium				
DCA253	711730	for 25x3 bare aluminium tape	50	0,030
DCA600	711760	for 25x3 PVC covered Al. tape	25	0,040
CDAS253	CDAS253	for 26x3	50	0,030
••• Stainless Steel				
DCSS253	DCSS253	for 26x3	50	0,032

Bare Tape Clips

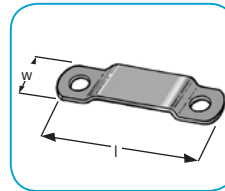

Minimum Order Required

Reference code	Part No.	Description	l mm	w mm		Unit weight kg
••• Copper						
TAPC253	711570	for 25x3 bare copper tape clip	40	15	25	0,500
TAPC506	711590	for 50x6 bare copper tape clip	69	15	25	0,800
••• PVC Covered Copper						
TAPC254	711580	for 25x3 PVC covered copper tape clip	44.5	15	25	0,500
••• Aluminium						
TAPA253	711550	for 25x3 bare aluminium tape clip	40	15	25	0,100

Non Metallic DC Tape Clips

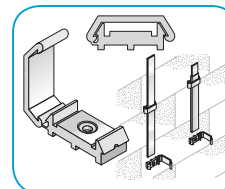

Reference code	Part No.	Colour		Unit weight kg
••• For use with 50x6 bare Cu/Al tape				
PDC506BL	711360	Black	50	0,02

Non Metallic Universal DC Clip/Base



Reference code	Part No.	Description	Colour		Unit weight kg
PDCUC	711352	Ø8 mm bare/insulated 25 mm x 3 mm bare/insulated 30 mm x 2 mm bare	Clear	50	0,007
PDCUCABBL	711341	Black adhesive base with hardware	Black	50	0,015
PDCUCABBN	711342	Brown adhesive base with hardware	Brown	50	0,015
PDCUCABGY	711343	Grey adhesive base with hardware	Grey	50	0,015
PDCUCABST	711344	Stone adhesive base with hardware	Stone	50	0,015
PDCUCABWH	711345	White adhesive base with hardware	White	50	0,015
PDCUCABGN	711346	Green adhesive base with hardware	Green	50	0,015

LIGHTNING PROTECTION

Slate Holdfast Non Metallic DC Clip & Glazing Bar Holdfast

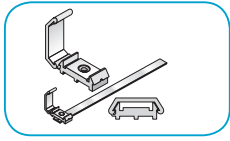

Reference code	Part No.		Unit weight kg
HFPDCUC	HFPDCUC	50	0,040

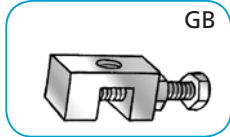

Glazing Bar Holdfast

Reference code	Part No.		Unit weight kg
••• Copper			
GBH C	710300	5	-
••• Aluminium			
GBH A	710305	5	-

One Hole Cable Clip

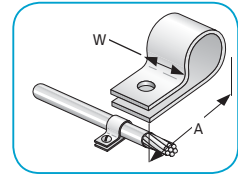

Reference code	Part No.	ø mm	A mm	W mm		Unit weight kg
••• Copper						
PC008C	711380	8	28	10	50	0,01
PC010C	711390	10	42	15	50	0,01
••• Aluminium						
PC008A	711370	8	28	10	50	0,01
PC010A	711040	10	42	15	50	0,01

Plate Type Test Clamp



Reference code	Part No.	Description		Unit weight kg
••• Copper				
PCT400	711450	26x12 mm	1	0,60

Square Tape Clamp

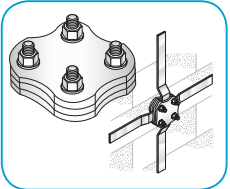
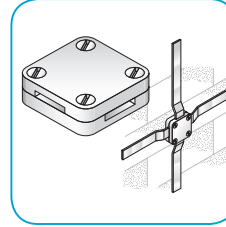

Reference code	Part No.	Description		Unit weight kg
••• Copper				
STC253	711410	25x3 mm	5	0,200
STC256-506	711510	25x6 mm to 50x6 mm	5	0,770
STCS253	STCS253	26x3 mm	5	0,100
••• Aluminium				
STA253	711400	25x3 mm	5	0,090
STAS253	STAS253	26x3 mm	5	0,058
••• Stainless Steel				
STSS253	STSS253	26x3 mm	5	0,092

Bi-Metallic Connectors

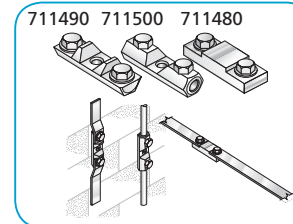

Reference code	Part No.	Description		Unit weight kg
••• Stainless Steel				
BIM800	711490	25x3 mm	5	0,200
BIM900	711500	round max 8 mm	5	0,200
••• Copper / Aluminium				
BIM700	711480	25x3 mm	5	0,190

Oblong Test or Junction Clamp

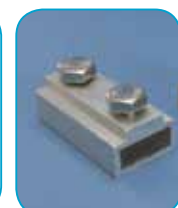
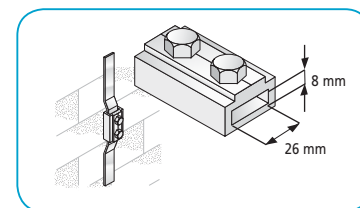

Reference code	Part No.	Description		Unit weight kg
••• Copper				
OBC268	711440	26x8 mm	2	0,290
••• Aluminium				
OBA268	711430	26x8 mm	2	0,100

LIGHTNING PROTECTION

Protective Sleeve For Down Conductor

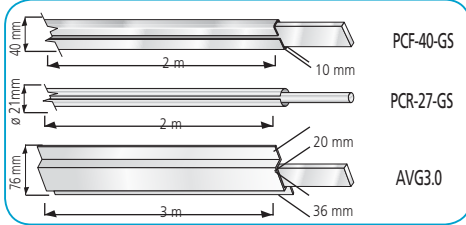

Reference code	Part No.	Description		Unit weight kg
••• Galvanised				
PCF40GS	102800	Protective sleeve for down conductors	1	1
PCR21GS	102850	Protective sleeve for round down conductors	1	0,90
AVG3.0	711030	Anti vandal guard	1	2,90

Brass Support For Downconductor

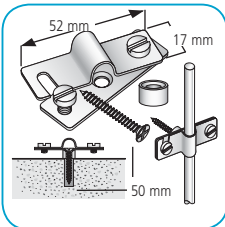

Reference code	Part No.		Unit weight kg
SR	545260	50	0,027

Anchor With Lead Pin

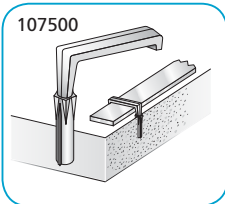

Reference code	Part No.	Description		Unit weight kg
••• Galvanized				
SDH3GI	107500	with lead pin	50	0,021

Multipurpose Clamp

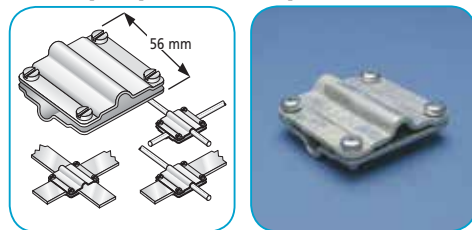

Reference code	Part No.	Material		Unit weight kg
••• Round 8 mm max or tape 30x2 mm max				
CCFR308	545270	Brass	25	0,150
CCS308	545170	Stainless steel	25	0,150
CCG308	545180	Galvanised steel	25	0,150

Earth Testing Clamp

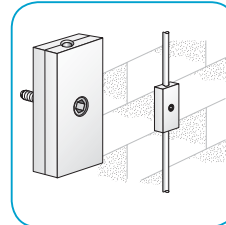

Reference code	Part No.		Unit weight kg
••• For Round max 10 mm or flat max 30 mm			
CCJ70CA	102700	1	0,4

Support Hooks For Roof Tiles

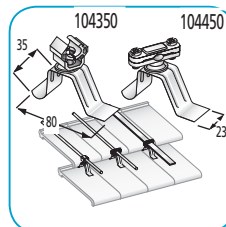

Reference code	Part No.	Conductor		Unit weight kg
••• Plastic / Stainless steel 55 mm height				
R2SRL25	104350	6 mm Ø	50	0,038
R2SFT25	104450	5-11 mm Ø or 30x2 mm	50	0,052

Supports With Adjustable Fastening Plate

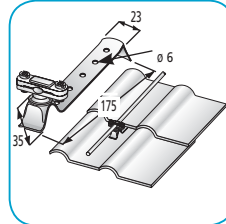

Reference code	Part No.	Conductor		Unit weight kg
••• Plastic / Stainless steel 35mm height				
R1SRL25A6	104200	6 mm Ø	50	0,042
R1SFT25	104300	5-11 mm Ø or 30x2 mm	50	0,042

Fixoband

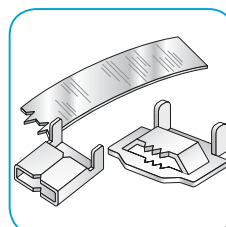

Reference code	Part No.	Description		Unit weight kg
CEI20	591080	Stainless steel bonding	100	0,009
FEI20	591230	Stainless steel buckle	50	0,104
BEI20	591280	Stainless steel serrated buckle	100	0,017
42014	591290	Fixoband Tool	1	1,800

LIGHTNING PROTECTION

Support For Hip or Ridge Tiles

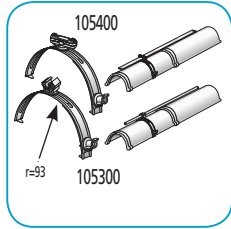

Reference code	Part No.	Conductor		Unit weight kg
• • • Diameter 180-260 mm, plastic / stainless steel				
T1SRL25/6	105300	6 mm Ø	10	0,092
T1SFT25	105400	5-11 mm Ø or 30x2 mm	10	0,105

Support For Round Conductor

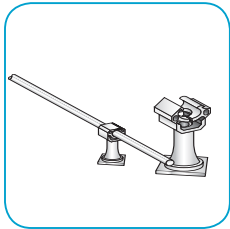

Reference code	Part No.	Conductor		Unit weight kg
• • • Plastic 16 mm height				
SRL23N6	103700	6 mm Ø	50	0,008
SRL23N8	103710	8 mm Ø	50	0,008
SRL23N10	103720	10 mm Ø	50	0,008

Plastic Support Blocks

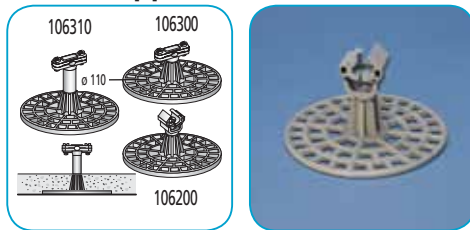

Reference code	Part No.	Conductor	Height		Unit weight kg
• • • Plastic					
SFRRSRL45/6	106200	6 mm Ø	45mm	10	0,014
SFRRSFT45	106300	5-11 mm Ø or 30x2	45mm	10	0,028
SFRRSFT65	106310	5-11 mm Ø or 30x2	65mm	10	0,029

Slide Rail For Roof Tile or Tile Slate

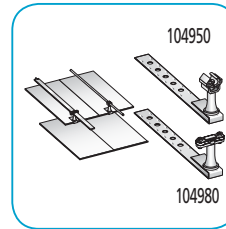

Reference code	Part No.	Conductor		Unit weight kg
• • • Plastic / stainless steel 40mm height				
R6SRL40/6	104950	6 mm Ø	50	0,069
R6SFT40	104980	5-11 mm Ø or 30x2	50	0,083

Plastic Support Part For Downconductor

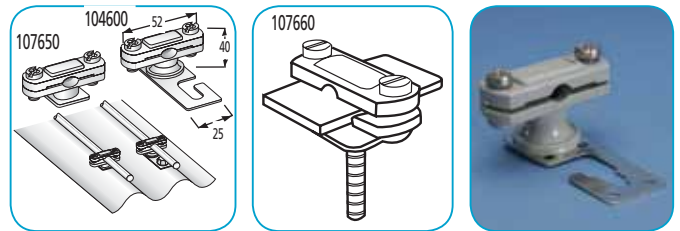

Reference code	Part No.	Conductor		Unit weight kg
• • • Plastic				
SFT23N	107650	5-11 mm Ø or 30x2 mm	50	0,020
SFTP23N	107660	5-11 mm Ø or 30x2 mm	50	0,020
R3SFT25	104600	5-11 mm Ø or 30x2 mm	50	0,037

Stainless Steel Clip & Waterproof Washer for 30X2

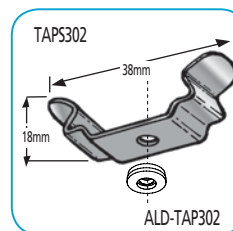

Reference code	Part No.		Unit weight kg
TAPS302	711620	100	0,002
ALDTAP302	711195	100	-

LIGHTNING PROTECTION

Blocks For Round or Flat Conductors

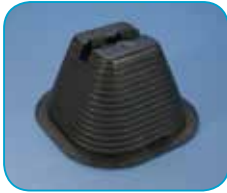
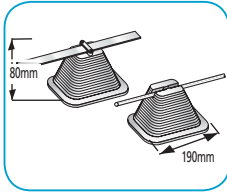

Reference code	Part No.	Conductor			Unit weight kg
SFRBC8	106030	8 mm Ø	Concrete	20	0,970
SFRBE8	106010	8 mm Ø	Empty	100	0,084
SFTBC	106080	5-11 mm Ø or 30x2	Concrete	20	0,982
SFTBE	106060	5-10 mm Ø or 30x2	Empty	100	0,100

T Connector

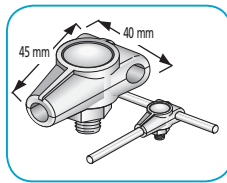

Reference code	Part No.	Material		Unit weight kg
• • • 8-10 mm diam.				
CTR10	101230	Galvanised	25	0,12
CTR8CU	710030	Copper	10	-
CTR8AL	710040	Aluminium	10	-

Cross Connector

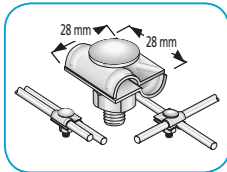

Reference code	Part No.	Material		Unit weight kg
• • • 6-8 mm diam.				
CCR68CU	101260	Copper	25	0,54
CCR68GS	101265	Galvanised steel	25	0,135
CCR608S	CCR608S	Stainless Steel	25	0,054

Slide Fastener Roofstile For Conductors



Reference code	Part No.		Unit weight kg
R7SFT20	702250	10	0,05

Hot Sticking Strip

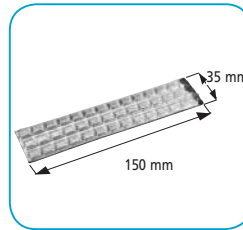

Reference code	Part No.		Unit weight kg
HSF	702240	10	0,02

CONDUCTORS - Minimum Order Quantity Required

Copper Cable

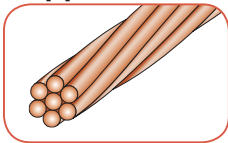

Without Insulation

Reference code	Part No.	Strand Description	Section mm ²		Unit weight kg
SCEC25	197900	7x2,14	25	50 m	0,23/m
SCEC35	197910	7x2,52	35	50 m	0,31/m
SCEC50	197920	19x1,78	50	50 m	0,46/m
SCEC70	197930	19x2,14	70	500 m	0,62/m
SCEC95	197940	19x2,52	95	500 m	0,85/m
SCEC120	710900	37x2,00	120	500 m	1,03/m
SCEC150	710920	37x2,25	150	500 m	1,33/m
SCEC185	197950	37x2,50	185	500 m	1,61/m

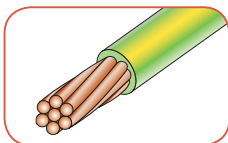

With Green / Yellow Insulation

Reference code	Part No.	Strand Description	Section mm ²		Unit weight kg
ICEC25	198000	204x0,395	25	50 m	0,27/m
ICEC35	198010	286x0,395	35	50 m	0,37/m
ICEC50	198020	408x0,395	50	50 m	0,53/m
ICECH25	198050	7x2,14	25	50 m	0,26/m
ICECH35	198060	7x2,52	35	50 m	0,36/m
ICECH50C	ICECH50C	10x2,67	50	50 m	0,52/m
ICECH70C	ICECH70C	14x2,67	70	500 m	0,72/m
ICECH95C	ICECH95C	19x2,67	95	500 m	0,98/m
ICECH120C	ICECH120C	24x2,67	120	500 m	1,16/m
ICECH150C	ICECH150C	30x2,67	150	500 m	1,54/m
ICECH185C	ICECH185C	37x2,67	185	500 m	2,10/m

Bare Copper Tape

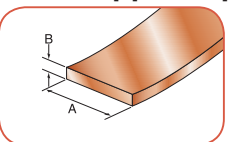

Reference code	Part No.	Width (A)mm	Thick. (B)mm		Unit weight kg
TCEC253025	710515	25	3,0	25 m	0,67/m
TCEC253050	710510	25	3,0	50 m	0,67/m
TCEC256015	710535	25	6,0	15 m	1,34/m
TCEC302030	197650	30	2,0	30 m	0,53/m
TCEC385010	710555	38	5,0	10 m	1,70/m
TCEC386030	710560	38	6,0	30 m	2,04/m
TCEC506020	710580	50	6,0	20 m	2,64/m

Tinned Copper Tape

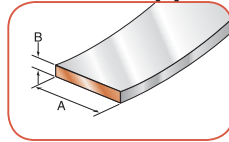

Reference code	Part No.	Width (A)mm	Thick. (B)mm		Unit weight kg
TCECT253030	197720	25	3,0	30 m	0,67/m
TCECT302030	197710	30	2,0	30 m	0,53/m
TCECT302075	545200	30	2,0	75 m	0,53/m
TCECT3160	TCECT3160	31	6,0	30 m	1,66/m
TCECT403030	197970	40	3,0	30 m	1,06/m
TCECT404035	197975	40	4,0	35 m	1,42/m
TCECT5060	TCECT5060	50	6,0	20 m	2,68/m

PVC Covered Copper Tape

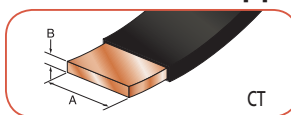

Reference code	Part No.	Colour	Dimensions AmmxBmm		Unit weight kg
CTBL25325	710595	Black	25x3,0	25 m	0,77/m
CTBN25325	710605	Brown	25x3,0	25 m	0,77/m
CTGN25325	710616	Green	25x3,0	25 m	0,77/m
CTGY25325	710645	Grey	25x3,0	25 m	0,77/m
CTST25325	710655	Stone	25x3,0	25 m	0,77/m
CTWH25325	710666	White	25x3,0	25 m	0,77/m
CTYGN25325	710667	Yell./Green	25x3,0	25 m	0,77/m
CTGN25630	710620	Green	25x6,0	30 m	1,55/m
CTGN50620	710630	Green	50x6,0	20 m	2,95/m

LSF Covered Copper Tape

Reference code	Part No.	Colour	Dimensions AmmxBmm		Unit weight kg
LSF253	710615	Green	25x3,0	50 m	0,77/m

Lead Covered Copper Tape

Reference code	Part No.	Width (A)mm	Thick. (B)mm		Unit weight kg
LCT253	710625	25	3,0	50 m	2,56/m

Plain Copper Bars

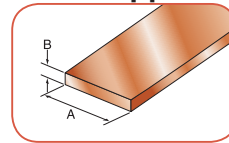

Reference code	Part No.	Dimensions mm		Unit weight kg
HDB2003	710670	20x3x4000	1	2,14
HDB2503	710680	25x3x4000	1	2,68
HDB2506	710690	25x6x4000	1	5,34
HDB3806	710700	38x6x4000	1	8,00
HDB5006	710710	50x6x4000	1	10,68
HDB5010	550900	50x10x4000	5	17,80

CONDUCTORS - Minimum Order Quantity Required

Tinned Copper Bar

Reference code	Part No.	Dimensions mm		Unit weight kg
THDB5060	710730	50x6x4000	1	10,68

Solid Copper Round Conductor

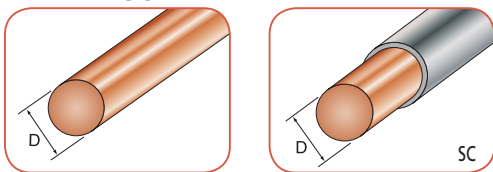

Bare Solid Copper Round Conductor

Reference code	Part No.	∅ (D) mm	Cross Section		Unit weight kg
RCEC6	198150	6	28,3	100 m	0,25/m
RCEC8	198160	8	50,3	100 m	0,45/m
RCEC83	545210	8	50,3	30 m	0,45/m

Tinned Solid Copper Round Conductor

Reference code	Part No.	∅ (D)mm	Cross Section		Unit weight kg
RCET6	198200	6	28,3	100 m	0,25/m
RCET8	198210	8	50,3	100 m	0,45/m

PVC Covered Solid Copper Round Conductor ∅ 8 mm

Reference code	Part No.	Colours	Cross Section		Unit weight kg
SCBL	710800	Black	50,3	50 m	0,49/m
SCBN	710810	Brown	50,3	50 m	0,49/m
SCGY	710820	Grey	50,3	50 m	0,49/m
SCST	710830	Stone	50,3	50 m	0,49/m

Copper Plates and Lattices / Grids

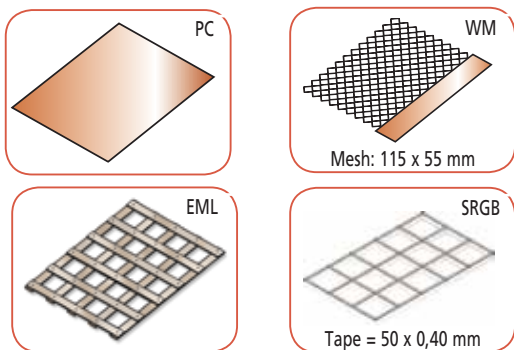

Copper Plates

Reference code	Part No.	Dimensions mm		Unit weight kg
PC1.50606	710190	600 x 600 x 1,5	1	5,000
PC30606	710200	600 x 600 x 3,0	1	9,600
PC1.50909	710210	900 x 900 x 1,5	1	11,510
PC2.1020	504550	1000 x 2000 x 2	1	35,600
PC30909	504590	900 x 900 x 3	1	21,630

Copper Lattices and Grids

Reference code	Part No.	Dimensions mm		Unit weight kg
EML663	710230	600 x 600 x 3	1	3,980
EML993	710240	900 x 900 x 3	1	7,200
WM32088B	504500	8800 x 2000 x 3	1	54,000
WM21030B	504510	3000 x 1000 x 2	1	5,000
WM31020B	504520	2000 x 1000 x 3	1	5,400
WM21020B	504530	2000 x 1000 x 2	1	4,000
••• Galvanised steel				
WMS1030B	504540	3000 x 1000 x 3	1	8,700

Signal Reference Grids

Reference code	Part No.	Length (m)	Width (m)	Spacing (m)		Unit weight kg
SRGBC120	167900	36,57	2,44	0,60	1	86,18
SRGBD100	167901	30,48	3,04	0,60	1	90,72
SRGBE100	167902	30,48	3,65	0,60	1	104,33
SRGBF100	167903	30,48	4,26	0,60	1	127,01
SRGBG100	167904	30,48	4,87	0,60	1	145,15

Universal Pedestal Clamp



Reference code	Part No.	Pedestal Size (round or square)		Conductor Size Range*
MBNUPCJ82	MBNUPCJ82	2,2 cm - 5,1 cm	25	10 mm ² - 35 mm ² (solid or stranded)

* All standard conductors with 7 or 19 strands.

Mesh Bonding Network Connector



Reference code	Part No.	Conductor Size Range*	
MBNC82	MBNC82	10 mm ² - 35 mm ² (solid or stranded)	25

* All standard conductors with 7 or 19 strands.

Bare Aluminium Tape

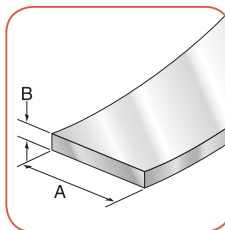

Reference code	Part No.	Width A mm	Thick B mm		Unit weight kg
FAT25350	710740	25	3	50 m	0,21/m
BAT2560	710960	25	6	50 m	0,41/m
BAT5060	710965	50	6	50 m	0,81/m

PVC Covered Aluminium Tape

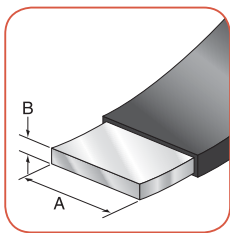

Reference code	Part No.	Width A mm	Thick B mm	Colours		Unit weight kg
ATBL253	710750	25	3	Black	50 m	0,30/m
ATBN253	710760	25	3	Brown	50 m	0,30/m
ATGY253	710770	25	3	Grey	50 m	0,30/m
ATST253	710780	25	3	Stone	50 m	0,30/m
ATWH253	710790	25	3	White	50 m	0,30/m

Bare Galvanised Steel Tape

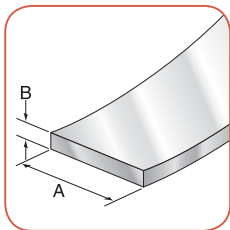

Reference code	Part No.	Width A mm	Thick B mm		Unit weight kg
30TCHGSP3035	197810	30	3,5	30 m	0,82/m

Bare Aluminium Round Conductor

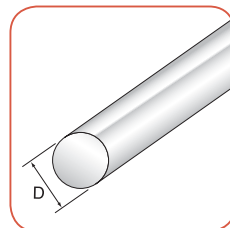

Reference code	Part No.	Cross-section mm ²	D ø mm		Unit weight kg
RAW8	198250	50,3	8	300 m	0,14/m
ASCO8	711530	50,3	8	50 m	0,14/m

PVC Covered Aluminium Round Conductor

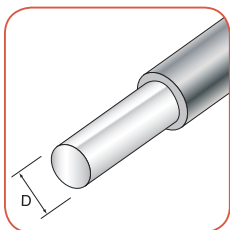

Reference code	Part No.	Cross-section mm ²	D ø mm	Colours		Unit weight kg
SABL	710840	50,3	8	Black	50 m	0,18/m
SABN	710850	50,3	8	Brown	50 m	0,18/m
SAGY	710860	50,3	8	Grey	50 m	0,18/m
SAST	710870	50,3	8	Stone	50 m	0,18/m

Bare Galvanised Round Conductor

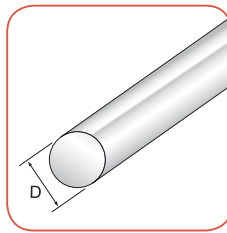

Reference code	Part No.	Cross-section mm ²	D ø mm		Unit weight kg
RSCC8	197860	50,3	8	100 m	0,400/m
RSCC10	197870	78,5	10	100 m	0,630/m

Theft Deterrent Composite Cable

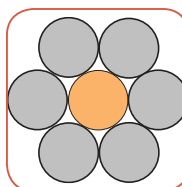

CC5A04

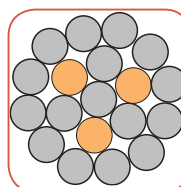

CC5A05

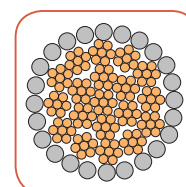

CC5A20

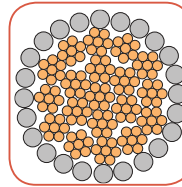

CC5A30

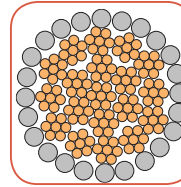

CC5A40

Reference Code	Part No.	Description	Outside Diameter	Fusing Capacity Equivalency		Unit weight kg
CC5A04	CC5A04	(1) Tinned Copper, (6) Galvanised Steel Strands	8.38 mm	100% of 16 mm ²	76 m	25,9
CC5A05	CC5A05	(3) Tinned Copper, (16) Galvanised Steel Strands	8.48 mm	100% of 16 mm ²	76 m	26,3
CC5A20	CC5A20	(133) Tinned Copper, (21) Galvanised Steel Strands	13.36 mm	100% of >50 mm ²	61 m	49,4
CC5A30	CC5A30	(133) Tinned Copper, (24) Galvanised Steel Strands	14.53 mm	100% of 70 mm ²	60 m	61,2
CC5A40	CC5A40	(133) Tinned Copper, (28) Galvanised Steel Strands	16.67 mm	100% of >95 mm ²	61 m	78,0

*Weight does not include reel.

Copper-bonded Steel Round Conductor

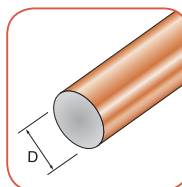

CC5A04

Reference Code	Part No.	Description	Outside Diameter		Unit weight kg
CSC8A70	CSC8A70	Copper-bonded Steel Wire	8 mm	100 m	0,410/m

GROUNDING & BONDING

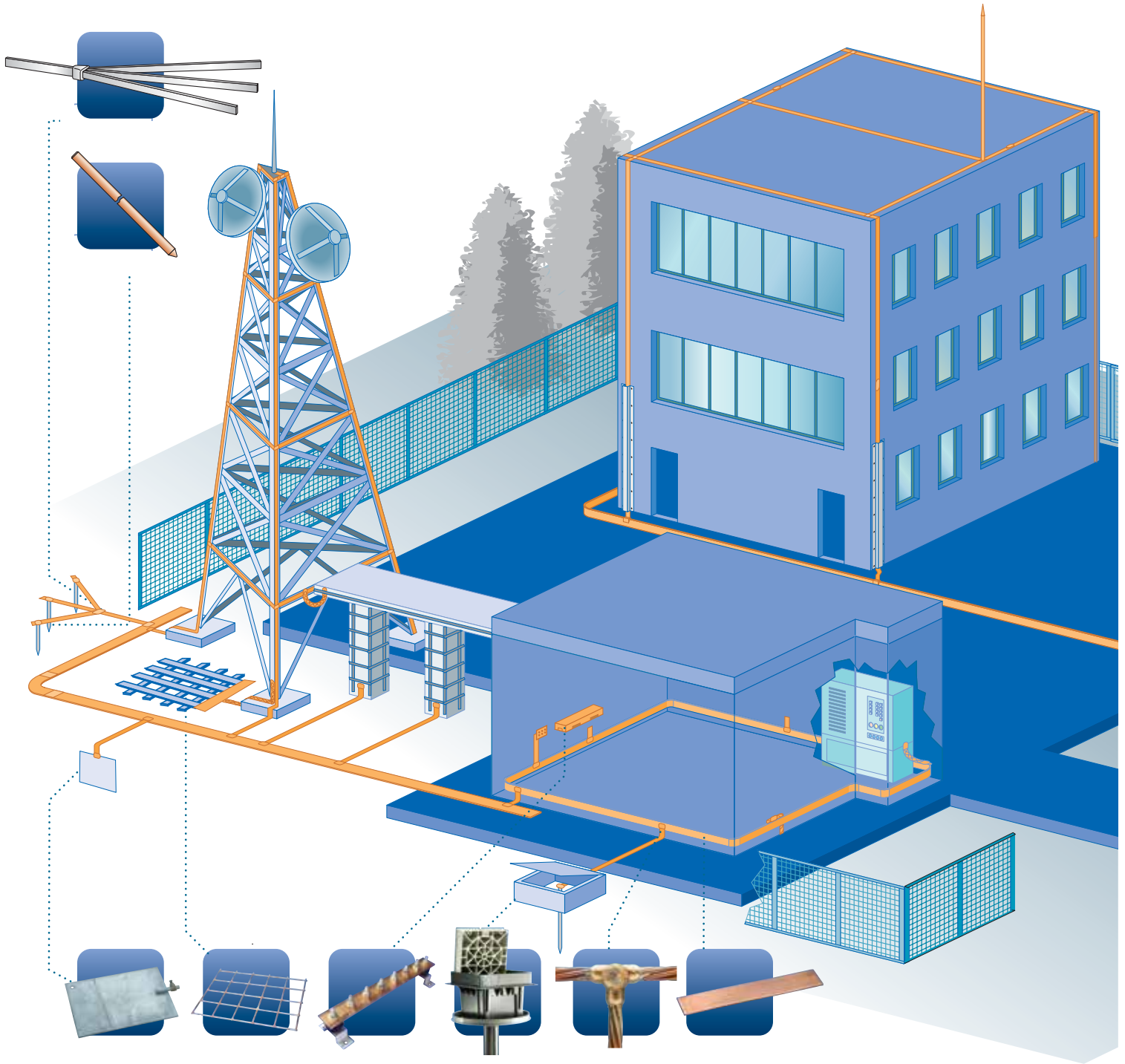

GROUNDING & BONDING

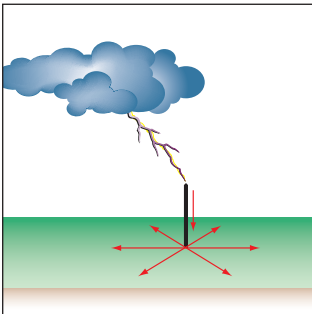

Radial Design

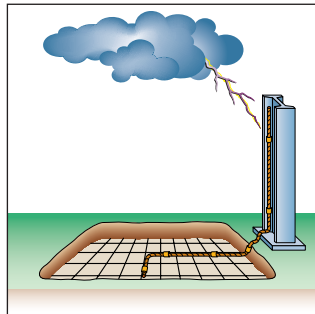

Equipotential Mesh Electrodes

Grounding Solutions

- High strength corrosion resistant ERICO ground rods, clamps and accessories
- Prefabricated wire mesh
- Ground Enhancement Material (GEM) greatly improves ground grid resistance and impedance
- CADWELD molecular bonding connections

GROUNDING & BONDING

Copper-bonded Pointed Ground Rods

- A uniform copper thickness provides better corrosion resistance in most soil conditions. Copper-bonded rods last longer, drive easier and will not crack.
- Copper exteriors, molecularly bonded to nickel-sealed high-strength steel cores, exceed the requirements of ANSI/UL 467-1984 (ANSI C33.8-1972) and CSA®.
- Copper Coating: standard copper plating thickness exceeds UL and ANSI specs. of 0.254mm, conforms to KEMA 83C and EN50164-2 Norms.
- The rods exceed a tensile strength of 515,000 kPa and straightness tolerance of 8.3 x 10-4m/m.
- Extending rods may be extended with use of threadless couplers.

TYPE CC Threadless Couplings for Copper-bonded Pointed Ground Rods

- Enables ground rods to be driven deep quickly and easily without the risk of rod separation.
- Made of high-strength silicon bronze.
- Tapered so that when the rod is driven into the coupling, the two parts compress to form a conductive connection.

Type DH Tempered Steel Driving Heads

Couplers

Earthrod pigtail

Copper-bonded Sectional Ground Rods

- Copper-bonded externally coupled ground rods have all the features of standard copper-bonded rods plus cold-rolled threads at each end for joining with couplings.
- The cold-rolled threads of ground rods with their continuous unbroken grain flows are stronger than cut-threads.
- High-strength couplings are threaded bronze and chamfered at both ends for easy driving.
- Threaded coupling design allows for full contact of rod point with butt end of preceding rod. These high strength, corrosion-resistant couplings ensure low resistance copper-to-copper connections.

Couplers for threaded rods

Steel driving studs for sectional ground rods

Type SCR (solid copper)

- C101 to comply with material standards.
- For use in highly corrosive soil conditions.

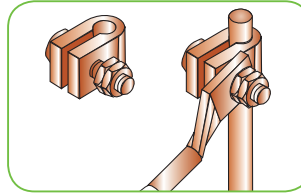

- Manufactured in gunmetal (LG2) and naval brass to comply with material standards
- Rod to cable lug clamps (threaded and unthreaded)
- Permits easy connection of ground conductors to both threaded and unthreaded ground rods

Type SSR (Stainless steel)

- A2 grade

Ground Rod Driver

This one tool enables driving of rods to ground level, without heavy sledge-hammers or ladders and without deforming the end of the rod. Heavy-duty steel construction provides robustness and excellent driving force, while the soft rubber ergonomic grip provides user comfort.



The ERICO brand of ground rod drivers from Pentair is the simple, effective and affordable way to install ground rods.

The ground rod driver includes driver body with soft rubber grip, insert for driving rods to ground level, and retaining collar which holds insert in place during storage.

- Usable on all types of round ground rods: copper-bonded, galvanised, stainless steel
- 14,2 mm (5/8") and 17,2 mm (3/4") inserts are interchangeable with standard driver body to enable easy driving of standard rods.
- The driver will not deform the end of the rod, making connection of the ground conductor quick and easy
- Integral insert helps prevent driver from slipping off the rod near ground level.
- Convenient retaining collar holds the insert in the tool when not in use.
- Self-contained and easy to store.
- Saves time and money and dramatically reduces risks of employee injury.

GROUNDING & BONDING

Copper-bonded Ground Rods Standard Type

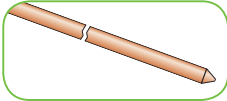

- Electrolytically copperbonded steel
- Copper coating min. 250u according to standard UL467

Reference code	Part No.	inches	Approx. Ø mm	Nominal Length		Unit weight kg
				m	feet	
••• Non extending						
1,2M38	155000	3/8	9	1,2	4'	0,650
1,5M38	155010	3/8	9	1,5	5'	0,800
2,1M38	155030	3/8	9	2,1	7'	1,100
3,0M38	155050	3/8	9	3	10'	1,600
••• Extending						
1,2M12	155060	1/2	12,5	1,2	4'	0,800
1,5M12	155070	1/2	12,5	1,5	5'	1,150
2,1M12	155090	1/2	12,5	2,1	7'	1,600
3,0M12	155110	1/2	12,5	3	10'	2,300
1,2M58	155240	5/8	14,2	1,2	4'	1,500
1,5M58	155250	5/8	14,2	1,5	5'	1,900
2,1M58	155270	5/8	14,2	2,1	7'	2,650
615880	615880	5/8	14,2	2,43	8'	3,071
3,0M58	155290	5/8	14,2	3	10'	3,750
1,2M34	155420	3/4	17,2	1,2	4'	2,150
1,5M34	155430	3/4	17,2	1,5	5'	2,750
2,1M34	155450	3/4	17,2	2,1	7'	3,800
613480	613480	3/4	17,2	2,43	8'	3,028
3,0M34	155470	3/4	17,2	3	10'	5,450

Threadless Couplings For Copper-bonded Pointed Rods

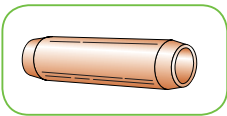

Reference code	Part No.	Rod ø	Unit weight kg
••• Bronze			
CC12F	158000	1/2"	0,108
CC58	158010	5/8"	0,134
CC34	158020	3/4"	0,202

Driving Heads For Copper-bonded Pointed Rods

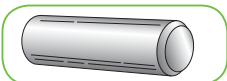

Reference code	Part No.	Rod ø	Unit weight kg
••• Tempered steel			
DH12	158120	1/2"	0,158
DH58	158130	5/8"	0,435
DH34	158140	3/4"	0,226

Driving Points For Ground Rods

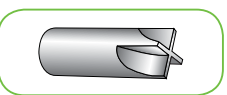

Reference code	Part No.	Rod ø	Unit weight kg
••• Tempered steel			
DT12	158060	1/2"	0,110
DT58	158070	5/8"	0,156
DT34	158080	3/4"	0,272

Copper-bonded Ground Rods Threaded Type, Extending, With Threaded Coupler

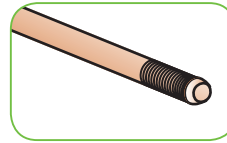

- Rolled thread to preserve copper coating

Reference code	Part No.	inches	Approx. Ø mm	Nominal Length		Unit weight kg
				m	feet	
S1,2M58	155300	5/8	14,2	1,2	4'	1,500
S1,5M58	155310	5/8	14,2	1,5	5'	1,900
S2,1M58	155330	5/8	14,2	2,1	7'	2,650
635880	635880	5/8	14,2	2,43	8'	4,560
S3,0M58	155350	5/8	14,2	3	10'	3,750
S1,2M34	155480	3/4	17,2	1,2	4'	2,150
S1,5M34	155490	3/4	17,2	1,5	5'	2,750
S2,1M34	155510	3/4	17,2	2,1	7'	3,800
633480	633480	3/4	17,2	2,43	8'	4,350
S3,0M34	155530	3/4	17,2	3	10'	5,450

Couplers For Threaded Rods

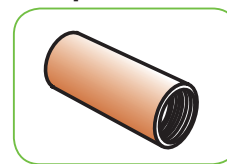

Reference code	Part No.	Rod ø	Unit weight kg
••• Bronze			
SC58	158040	5/8"	0,086
SC34	158050	3/4"	0,172

Driving Stud For Threaded Rods

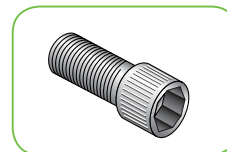

Reference code	Part No.	Rod ø	Unit weight kg
••• Tempered steel			
DS58	158100	5/8"	0,074
DS34	158110	3/4"	0,126

Threaded Driving Tip SDT Series

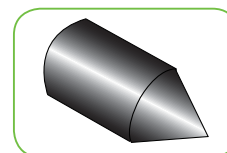

Reference code	Part No.	Rod ø	Unit weight kg
••• Tempered steel			
SDT58	SDT58	5/8"	0,040
SDT34	SDT34	3/4"	0,070

GROUNDING & BONDING

Ground Resistance Tester



Reference code	Part No.		Unit weight kg
EST3640	EST3640	1	15,880
EST4620	EST4620	1	2,85
EST4630	EST4630	1	15,880
EST6472	EST6472	1	16,818

Technical data available upon request.

Ground Enhancement Material (GEM)



Developed in 1992, GEM Ground Enhancement Material is a superior conductive material that solves your toughest grounding problems.

GEM improves grounding effectiveness regardless of soil conditions. It is the ideal material to use in areas of poor conductivity such as rocky ground, mountain tops and sandy soil.

GEM is also the answer in situations where ground rods can't be driven. Or where limited land area makes adequate grounding difficult with conventional methods.

Once GEM is installed, it maintains its low resistance for the life of the project. GEM's performance is backed by rigorous independent tests and proven field experience.

Reference code	Part No.		Unit weight kg
GEM25A	163670	1	11,500
GEM25ABKT	GEM25ABKT	1	11,793

Earthrod Pigtail For Ground Rods

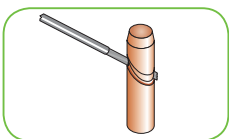

Reference code	Part No.	rod ø	Cable size mm ²	Cable length mm		Unit weight kg
PT1225/300	158610	1/2"	25	300	50	0,180
PT5825/300	158675	5/8"	25	300	50	0,200
PT5835/300	158690	5/8"	35	300	50	0,200
PT5850/300	158290	5/8"	50	300	50	0,365

ERICO HAMMERLOCK



Part No.	Rod ø	Conductor range		Unit weight kg
EHL12FC1K	1/2"	10-16 mm ² str	25	0,137
EHL12FC1V	1/2"	22-35 mm ² str*	25	0,134
EHL12FC2G	1/2"	50-70 mm ² str**	25	0,134
EHL58C1K	5/8"	10-16 mm ² str	25	0,129
EHL58C1V	5/8"	22-35 mm ² str*	25	0,116
EHL58C2G	5/8"	50-70 mm ² str**	25	0,209
EHL34C1K	3/4"	10-16 mm ² str	25	0,213
EHL34C1V	3/4"	22-35 mm ² str*	25	0,159
EHL34C2G	3/4"	50-70 mm ² str**	25	0,169

••• Dual-Hole (2 Conductors)

EHL12FC1K1K	1/2"	10-16 mm ² str	25	0,134
EHL58C1K1K	5/8"	10-16 mm ² str	25	0,209

* 6 mm solid ** 8 mm solid

Solid Copper or Stainless Steel Ground Rods & Accessories

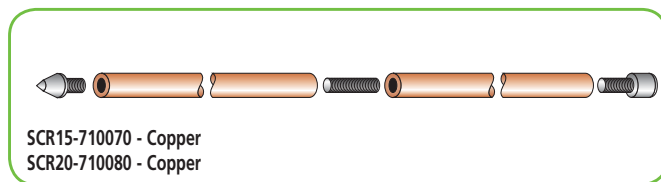

SCR15-710070 - Copper

SCR20-710080 - Copper

Solid Copper Internal Threaded Ground Rods Type SCR

Reference code	Part No.	Rod ø mm	L		Unit weight kg
SCR15	710070	15	1,20 m	5	1,64
SCR20	710080	20	1,20 m	5	3,34

Minimum Order Quantity Required

Accessories For Solid Copper Threaded Ground Rods Type SCR

Reference code	Part No.	Rod ø mm		Unit weight kg
••• Steel driving stud (15 mm) for SCR15				
CDS15	710090	15	5	0,020
••• Steel driving stud (20 mm) for SCR20				
CDS20	710100	15	5	0,050
••• M10 Phosphor bronze internal coupling Dowel (PB102) for SCR15 and SCR20				
PBD10	710110	10	5	0,020
••• Driving point for SCR 15 (15 mm)				
SPK15	710120	15	5	0,020
••• Driving point for SCR 20 (20 mm)				
SPK20	710130	20	5	0,050

GROUNDING & BONDING

Stainless Steel Internal Threaded Ground Rods Type SSR



SSR16-710010 - Stainless steel

Reference code	Part No.	diam. mm	length m		Unit weight kg
SSR16	710010	16	1.20	5	1,640

Accessories For Stainless Steel Threaded Ground Rods Type SSR

Reference code	Part No.	Rod ø mm		Unit weight kg
••• Steel driving stud (15 mm) for SSR16				
CDS15	710090	15	5	0,020
••• M10 Stainless steel internal coupling dowel				
SSD10	710115	10	5	0,020
••• Driving point for SSR16				
SPK15	710120	15	5	0,020

Galvanised Steel Ground Rods Type CG (Non Extensible) (X-Shaped)



- Supplied with splice plate
- Zinc coating: min 55 micron/ Average min. 70 micron

Reference code	Part No.	Length m		Unit weight kg
••• Section 50 x 50 x 3				
1,0CG50/3	158760	1	20	2,340
1,5CG50/3	158770	1,5	20	3,510
2,0CG50/3	158780	2	20	4,680

Minimum Order Quantity Required

Galvanised Steel Ground Rods Type SG (Extensible)

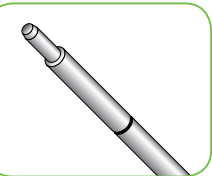

Reference code	Part No.	Length m	ø mm		Unit weight kg
1,5SG20	158810	1,5	20	5	3,705

Minimum Order Quantity Required

Driving Points For Ground Rods SG

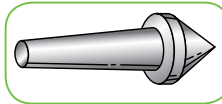

For Ground Rods SG

Reference code	Part No.	Rod ø mm		Unit weight kg
••• Tempered steel				
DTP137120	158400	20	5	0,200

Stainless Steel Ground Rods Type SS (Extensible)

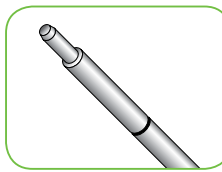

- Stainless steel Z30 C13
- Resistance: > 90 / 100 daN / mm²

Reference code	Part No.	Length m	ø mm		Unit weight kg
15SS20	158540	1,5	20	25	3,700

Driving Points For Ground Rods SS

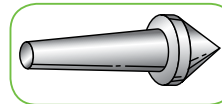

Reference code	Part No.	Rod ø mm		Unit weight kg
••• Tempered steel				
DTP1120SS	158550	20	25	0,040

Driving Head For Ground Rods SG & SS

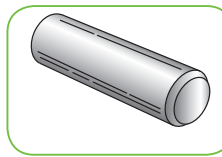

Reference code	Part No.	Rod ø mm		Unit weight kg
••• Tempered steel				
DHTR167	158380	20	5	0,200

GROUNDING & BONDING

Connecting Clamp For Cable to Ground Rods SG & SS



Reference code	Part No.	Rod ø mm		Unit weight kg
••• Copper/Steel - Cable capacity 70mm ²				
S13620	158440	20	5	0,070

Ground Rod Driver



Reference code	Part No.	Description		Unit weight kg
EGRD58	158500	1,5 m driver body with insert for up to 14,2 mm	1	10,420
EGRD58L	158510	Replacement insert for 14,2 mm (5/8")	1	2,720
EGRD34	158520	Driver body with insert for up to 17,2	1	10,420
EGRD34L	158530	Replacement insert for 17,2 mm (3/4")	1	2,720

Conductor to Ground Rod Clamp

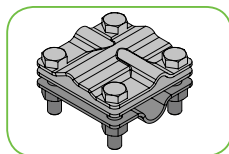

Reference code	Part No.	Description	Conductor Size		Ground Rod Size	
			Tape	Wire/Cable		
MPSC404SS	120319	Conductor to ground rod clamp	up to 40 mm	from 35 to 50 mm ²	5/8" and 3/4"	5

Saddle and Rod Clamps



Reference code	Conductor range	
	area (mm ²)	ø mm
GUV16070	16-70	5,1-10,7
GUV70185	70-185	10,7-17,6

Reference code	Part No.	Nominal Rod ø mm		Unit weight kg
••• Gunmetal + Copper U bolt				
UB16	710370	16	10	0,200
UB20	710380	20	10	0,200
UB25	710390	25	10	0,210
GUV16070	710400	10-20	5	0,390
GUV70185	710410	16-20	5	0,440

Rod to Tape Disconnect Clamp (Type A)

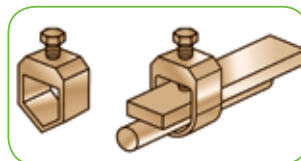

Reference code	Part No.	Clamp capacity			Unit weight kg
		A mm	B mm		
••• Gunmetal					
RTC1626	158410	26x12	16	10	0,160
RTC2030	710345	31x10	20	10	-
RTC2051	710350	51x12	20	10	0,310
RTC2526	710360	26x10	25	10	0,230

Rod to Cable Clamps (Type C)

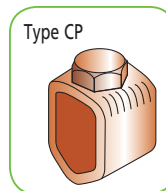
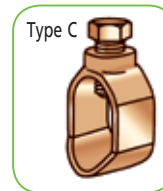

Conductor Capacity
Type C: Max 70 sq mm
Type CP: Max 25 sq mm

Reference code	Part No.	Rod ø in mm		Unit weight kg
••• Gunmetal				
C12	158260	12,5-12,7	5	0,040
C58	158160	12,5-15,0	5	0,084
C34	158170	14,2-17,2	5	0,086
C19	156900	14,2-19,0	5	0,085
C20	156910	14,2-20,0	5	0,125
C1	158250		5	0,110
••• Bronze				
Cond. size cross section				
CP38	158155	Max 16 sq mm	100	0,022
CP58	158165	Max 25 sq mm	50	0,059
CP34	158175	Max 25 sq mm	50	0,077

SP58 Stainless Steel Ground Rod Clamp



Reference code	Part No.	Electrodes Ground Rod Sizes	Rebar	Conductor Sizes	Min. Torque Withstand	
SP58	158185	12.7 mm - 16.0 mm	10 mm	6 mm ² - 25 mm ²	33.9 N/M	50

GROUNDING & BONDING

Rod to Tape Lug (Split Clamp)

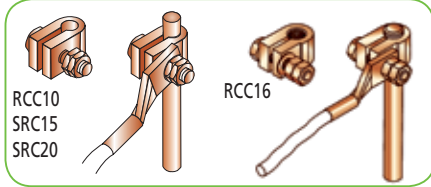

Reference code	Part No.	Description	Unit weight kg
••• Gunmetal			
RCC10	710420	9,5 mm plain split clamp	10 0,090
RCC16	710430	16 mm split clamp (threaded)	10 0,340
SRC15	710440	14,2-15 mm plain split clamp (SCR) for solid copper rod	10 0,330
SRC20	710450	20 mm plain split clamp (SCR) for solid copper rod	10 0,300

Prefabricated Crowsfeet

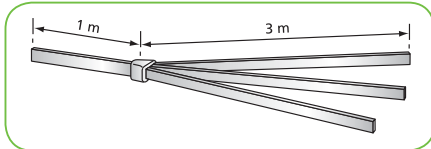

Reference code	Part No.	Rod ø in mm	Unit weight kg
GF-302	503900	Tinned copper 30 x 2	1 5,500

Inspection Pits

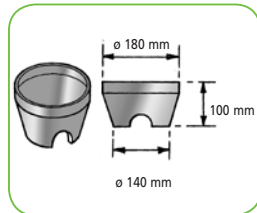
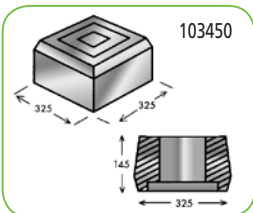
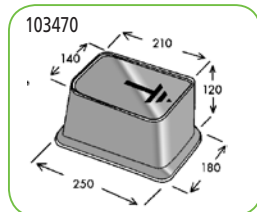
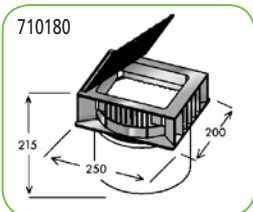

Reference code	Part No.	Material	Dimensions mm	Unit weight kg
PIT03	710180	Plastic	250x200x215	1 1,350
IP-900-C	103450	Concrete	325x325x145	1 27
IP-R193x122MM	103470	Cast iron	210x140x120	1 7
IP-SQ-180-CI	103480	Cast iron	ø180	1 2,400

Earth Bars For Inspection Pits

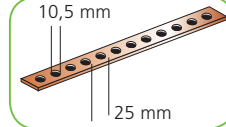

Reference code	Part No.	Dimensions & No. of holes	Designed to suit earth pit	Unit weight kg
••• Copper				
BEP25x5x300MM	545140	25x5x300 mm 12 holes	Concrete earth pit IP-900-C(103450)	1 0,300
BEP25x5x200MM	545135	25x5x200 mm 8 holes	Plastic earth pit PIT03(710180)	1 0,260
BEP25x5x150MM	545530	25x5x150 mm 6 holes	Cast iron earth pit IPR193(103470) IP180(103480)	1 0,150

Earth Rod Seal Kits



Reference code	Part No.	Description	Unit weight kg
WGRS200	158922	Double flange earth rod seal*	1 4,3

* Includes PIT05 Heavy Duty Earth Inspection Kit. The Double Flange version is delivered as a kit, which includes a 1,2 m PVC pipe, to be adjusted to site conditions. Kit is assembled with PIT05 (158923).

Tape Metal Support For Foundations or Trenches and Tape Metal Wall Support

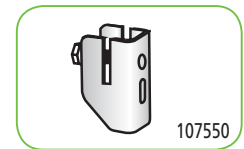

Tape Metal Support For Foundations or Trenches

• Keeps the tape in a vertical position

Reference code	Part No.	Rod height mm	Unit weight kg
••• Galvanised steel			
STBF-25-GS	107600	250	25 0,200
STBF-40-GS	107610	400	25 0,340

Tape Metal Wall Support

Reference code	Part No.	Material	Unit weight kg
••• For tape below 6 mm thick			
SSF-6-GS	107550	Galvanised steel	25 0,130
SSF-6-C	107560	Copper	25 0,140

GROUNDING & BONDING

Tower Earth Clamp

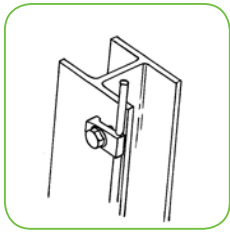
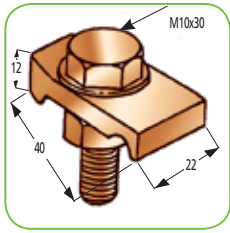

Reference code	Part No.		Unit weight kg
••• Copper - ø 8mm			
TECLP8CU	710050	10	0,090
••• Aluminium - ø 8mm			
TECLP8AL	710060	10	0,058

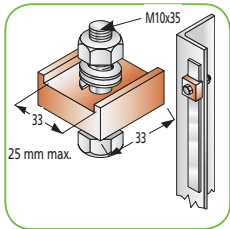

Reference code	Part No.		Unit weight kg
••• Copper - suit 26 mm max tape width			
BBBC	710260	25	0,12
••• Aluminium - suit 26 mm max tape width			
ABBC	710250	25	0,60

Pipe Collars

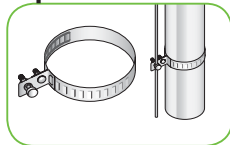

Reference code	Part No.	ø min. / max.		Unit weight kg
••• Stainless steel - conductor, 6 to 11 mm diameter				
SPC5080S	107000	50/80	10	0,147
SPC70120S	107010	70/120	10	0,170
SPC130180S	107020	120/170	10	0,214
••• Copper - conductor, 6 to 11 mm diameter				
SPC5080C	107050	50/80	10	0,165
SPC70120C	107060	70/120	10	0,191
SPC130180C	107070	120/170	10	0,240

Fasteners For Gutter Rim

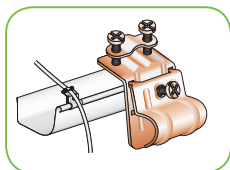

Reference code	Part No.		Unit weight kg
••• Copper - conductor, 6 to 10 mm			
SGR6102	107230	10	0,067

Earth Bar Support

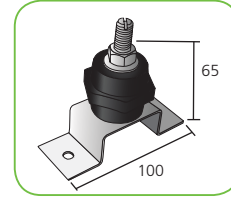

Reference code	Part No.		Unit weight kg
FEB35M10	FEB35M10	1	0,186

Earth Bars

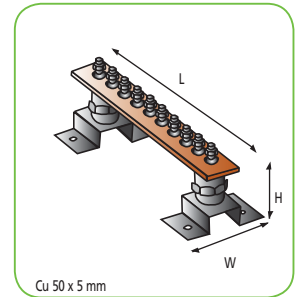

Reference code	Part No.	Nr of terminals	Disconnect links	L mm	W	H		Unit weight kg
DLUNI	545000	-	1	125	100	94	1	1,192
SEB06	545010	6	0	400	100	94	1	1,642
SEB06DL	545020	6	1	475	100	94	1	2,400
SEB08	SEB08	8	0	500	100	94	1	1,863
SEB10	545030	10	0	600	100	94	1	2,312
SEB10DL	545040	10	1	675	100	94	1	2,800
SEB62DL	545130	6	2	550	100	94	5	3,200

NB: terminals do include Nuts and Bolts

Earth Plate Set

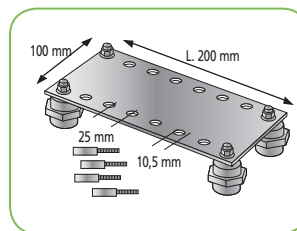

• 16 connection points

Reference code	Part No.		Unit weight kg
••• Tinned copper 100 x 5			
SEP	545190	1	1,02

GROUNDING & BONDING

GROUNDING & BONDING

Intersystem Bonding Termination (IBTB)

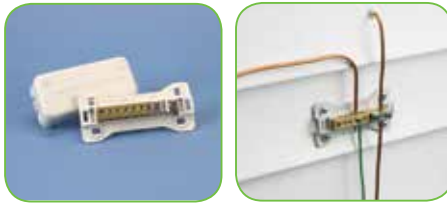

Reference code	Part No.	H x D x W (mm)		Unit weight kg
IBTB	IBTB	101,6 x 35,82 x 51,06	1	0,136

Earth Blocks

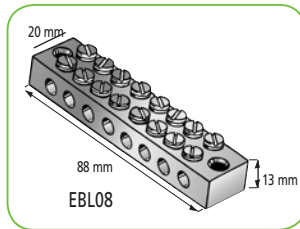

EBL08
- 6 x ø 5,2 mm
- 2 x ø 6,5 mm

Reference code	Part No.		Unit weight kg
••• Tinned brass			
EBL08	711470	10	0,158

Double Connecting Plate

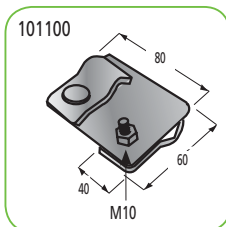

Supporting plate for the connection of round conductors, diameter 10 mm, or flat conductors up to 40 x 4 mm on rebars up to 24 mm ø.

Reference code	Part No.	Conductor	Rebar		Unit weight kg
••• Galvanised steel					
CPD2440	101100	10 mm dia or 40x4	24 mm dia	25	0,340

Rebar Clamps



Reference code	Part No.	Conductor	Rebar		Unit weight kg
••• Galvanised steel					
RC70	710325	8 mm dia	8-18 mm	1	0,340
RC100	710335	8 mm dia	18-38 mm	1	0,780
EK16	710355	25 mm ²	25 mm-parallel	50	0,091
EK17	710365	25 mm ²	25 mm-perpendicular	50	0,091

Earth Boss

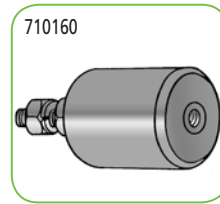

Reference code	Part No.	Length mm	ø mm		Unit weight kg
50010EBOSS	710160	50	50	1	-

Static Earthing

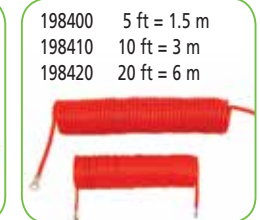
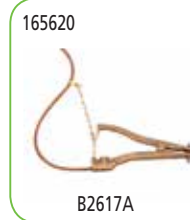

Reference code	Part No.	Description		Unit weight kg
B2610A	165410	Spring clamp	1	0,144
B2617A	165620	Aircraft grounding clamp	1	1,140
A822SA111C5	198400	Orange coiled cable, 5 ft (1.5 m)	1	0,450
A822SA111C10	198410	Orange coiled cable, 10 ft (3 m)	1	0,540
A822SA111C20	198420	Orange coiled cable, 20 ft (6 m)	1	0,820
B2618B	165400	Cable reel assembly	1	3,150

Fence Clamps



Reference code	Part No.	Conductor Size - Metric	Pipe Size - Metric
FC073	198401	16 mm ² Str - 70 mm ² Str	40 mm
FC074	198402	70 mm ² Str - 120 mm ² Str	40 mm
FC075	198403	16 mm ² Str - 70 mm ² Str	50 mm
FC076	198404	70 mm ² Str - 120 mm ² Str	50 mm
FC078	198406	16 mm ² Str - 120 mm ² Str	65 mm
FC079	198407	16 mm ² Str - 70 mm ² Str	80 mm
FC080	198408	70 mm ² Str - 120 mm ² Str	80 mm
FC082	198411	16 mm ² Str - 120 mm ² Str	90 mm

GROUNDING & BONDING

Eyes Bolts For Copper-bonded Ground Rods

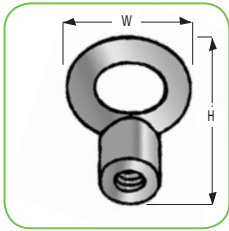

Reference code	Part No.	ø inch	W	H		Unit weight kg
EBR58	710140	5/8"	68	96	5	-
EBR34	710150	3/4"	68	96	5	-

Grounding Receptacles

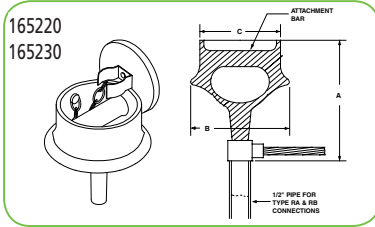
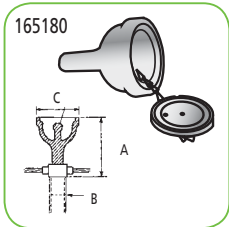

These receptacles provide earth connections for the frames of planes, ships, tankers trucks, etc. eliminating their electrostatic charge and obtaining equipotentiality with the surrounding earth.

Parts are copper alloy, connections to the earth circuit can be made with CADWELD.

Reference code	Part No.	Attachment	Depth A	ø B	ø C		Unit weight kg
B165	165180	Cast 3/4" ball	4 1/2"		2 3/4"	1	0,800
B166	165220	Cast 3/4" rod	6 1/4"	4 3/4"	3 7/8"	1	2,100
B167	165230	Cast 1-1/2" rod	7 1/4"	6 1/2"	4 3/4"	1	7,000

Denso Tape (DT) and Silfos Tape (SFO)



Reference code	Part No.		Unit weight kg
DT50	711520	10 m x 50 mm	0,760
SFO50	710170	8 m x 50 mm	0,430

Potential Equalisation Clamp (PEC)



Reference code	Part No.		Unit weight kg
PEC100	702900	1	0,500
PEC150	702901	1	0,544

Oxide Inhibiting Compound

Reference code	Part No.		Unit weight kg
OXINHIBCOMP	710220	1	0,314

MBJ Ground Braids

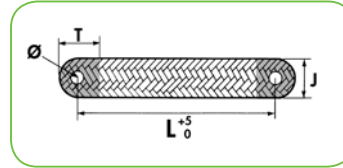

- Excellent electrical contact due to integral palms
- Good resistance to vibration and fatigue
- Recommended by the EMC directives
- UL recognised E220029
- Excellent tensile strength

*Refer to the ERICO Low Voltage Power Distribution catalog from Pentair.

GROUNDING & BONDING

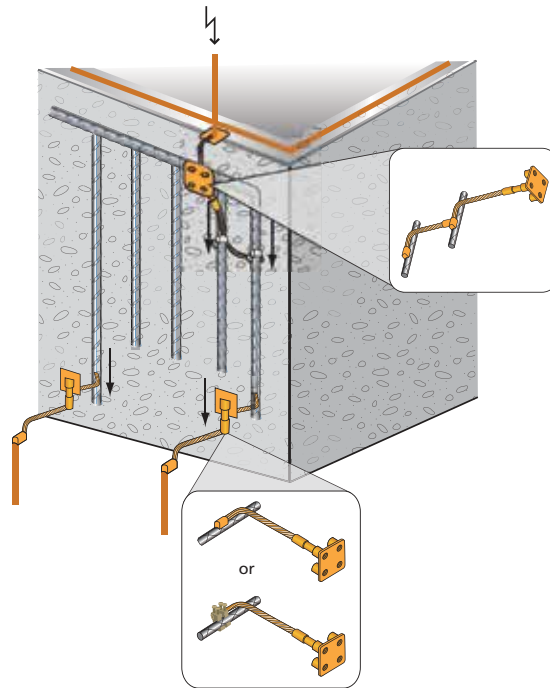

Earth Points

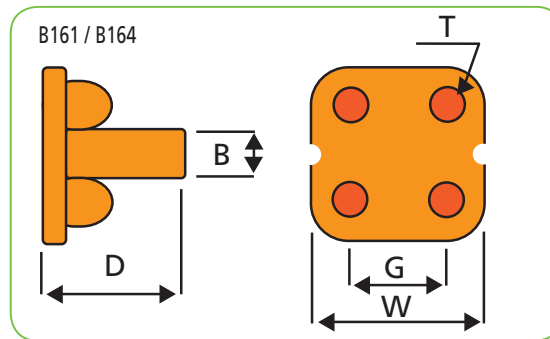
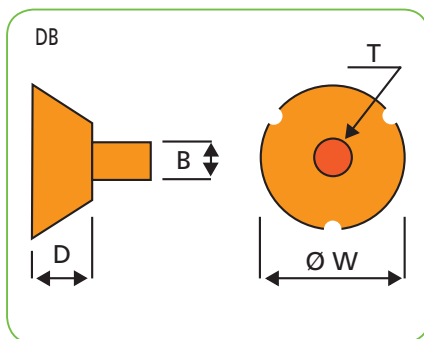

Earthpoints to be welded using CADWELD

Type	Part No.	Reference	Width W	Depth D	Terminal Size T	No. of Terminals	Tail Size B	PU
DB	166120	DB-10A	50 mm	55 mm	M10	1	16 mm Ø	5
DB	166150	DB12A	50 mm	55 mm	M12	1	16 mm Ø	5
DB	166180	DB-16A	50 mm	55 mm	M16	1	16 mm Ø	5
B161	166030	B161-10B	65 mm	30 mm	M10	4	14 mm Ø	1
B164	166060	B164-12A	85 mm	75 mm	M12	4	10.7 mm Ø	1

GROUNDING & BONDING

Earth Points

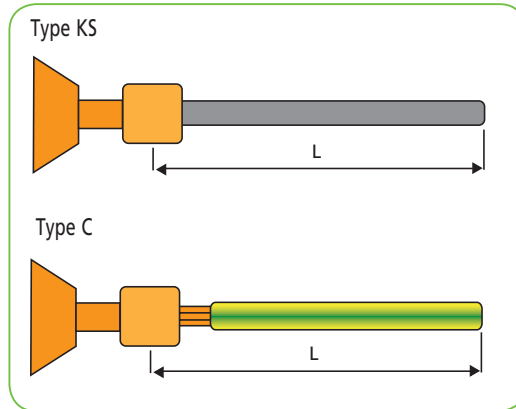
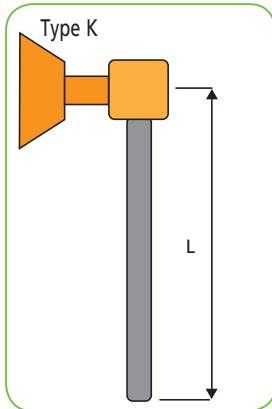

Earthbridges welded using CADWELD by Pentair specialists in our production plants (Prefabricated)

Type	Design	Part No.	Reference	Width W	Depth D	Terminal Size T	No. of Terminals	Conductor Material	Conductor Size	Conductor Length L	PU
DB	K	166130	DB-10K	50 mm	55 mm	M10	1	Bare Steel	16 mm Ø	500 mm	1
DB	KS	166140	DB10KS	50 mm	55 mm	M10	1	Bare Steel	16 mm Ø	500 mm	1
DB	KS	DB10KS12350	DB-10KS12350	50 mm	55 mm	M10	1	Bare Steel	12 mm Ø	350 mm	1
DB	C	166480	DB-10-C5005	50 mm	55 mm	M10	1	PVC Covered Copper Cable	50 mm ²	500 mm	1
DB	C	166490	DB-10-C501	50 mm	55 mm	M10	1	PVC Covered Copper Cable	50 mm ²	1000 mm	1
DB	C	166500	DB-10-C502	50 mm	55 mm	M10	1	PVC Covered Copper Cable	50 mm ²	2000 mm	1
DB	C	DB10C70500	DB10C70500	50 mm	55 mm	M10	1	PVC Covered Copper Cable	70 mm ²	500 mm	1
DB	C	DB10C701000	DB10C701000	50 mm	55 mm	M10	1	PVC Covered Copper Cable	70 mm ²	1000 mm	1
DB	K	166160	DB-12K	50 mm	55 mm	M12	1	Bare Steel	16 mm Ø	500 mm	1
DB	KS	166170	DB-12KS	50 mm	55 mm	M12	1	Bare Steel	16 mm Ø	500 mm	1
DB	K	166190	DB-16K	50 mm	55 mm	M16	1	Bare Steel	16 mm Ø	500 mm	1
DB	KS	166200	DB-16KS	50 mm	55 mm	M16	1	Bare Steel	16 mm Ø	500 mm	1
B161	C	166510	B161-10-C5005	65 mm	30 mm	M10	4	PVC Covered Copper Cable	50 mm ²	500 mm	1
B161	C	166520	B161-10-C501	65 mm	30 mm	M10	4	PVC Covered Copper Cable	50 mm ²	1000 mm	1
B161	C	166530	B161-10-C502	65 mm	30 mm	M10	4	PVC Covered Copper Cable	50 mm ²	2000 mm	1
B161	K	166040	B161-10KA	65 mm	30 mm	M10	4	Bare Steel	12 mm Ø	500 mm	1
B161	KS	166050	B161-10KM	65 mm	30 mm	M10	4	Bare Steel	12 mm Ø	500 mm	1
B164	K	166070	B164-12K	85 mm	75 mm	M12	4	Bare Steel	12 mm Ø	400 mm	1
B164	KS	166080	B164-12KS	85 mm	75 mm	M12	4	Bare Steel	12 mm Ø	400 mm	1

Important Notice:

For large projects, specific "Bulk Delivery" is recommended.

Please see below list of specific Part No. Please note that there is a MOQ (Minimum Order Quantity) of 50 pcs to consider.

Components and products performances remain unchanged.

Type DB	Part No.	Reference	Thread A	Diam. C	L	MOQ
90° angle	166130B	DB-10K16 BLK	M10	16 mm	500 mm	50
90° angle	166140B	DB-12K16 BLK	M12	16 mm	500 mm	50
Straight	166160B	DB-10KS16 BLK	M10	16 mm	500 mm	50
Straight	166170B	DB-12KS16 BLK	M12	16 mm	500 mm	50

Packaging Type: Loose in a cardboard box or wooden crate (upon quantity)
 Packing Unit: Minimum Order Qty of 50 pcs

SURGE PROTECTION

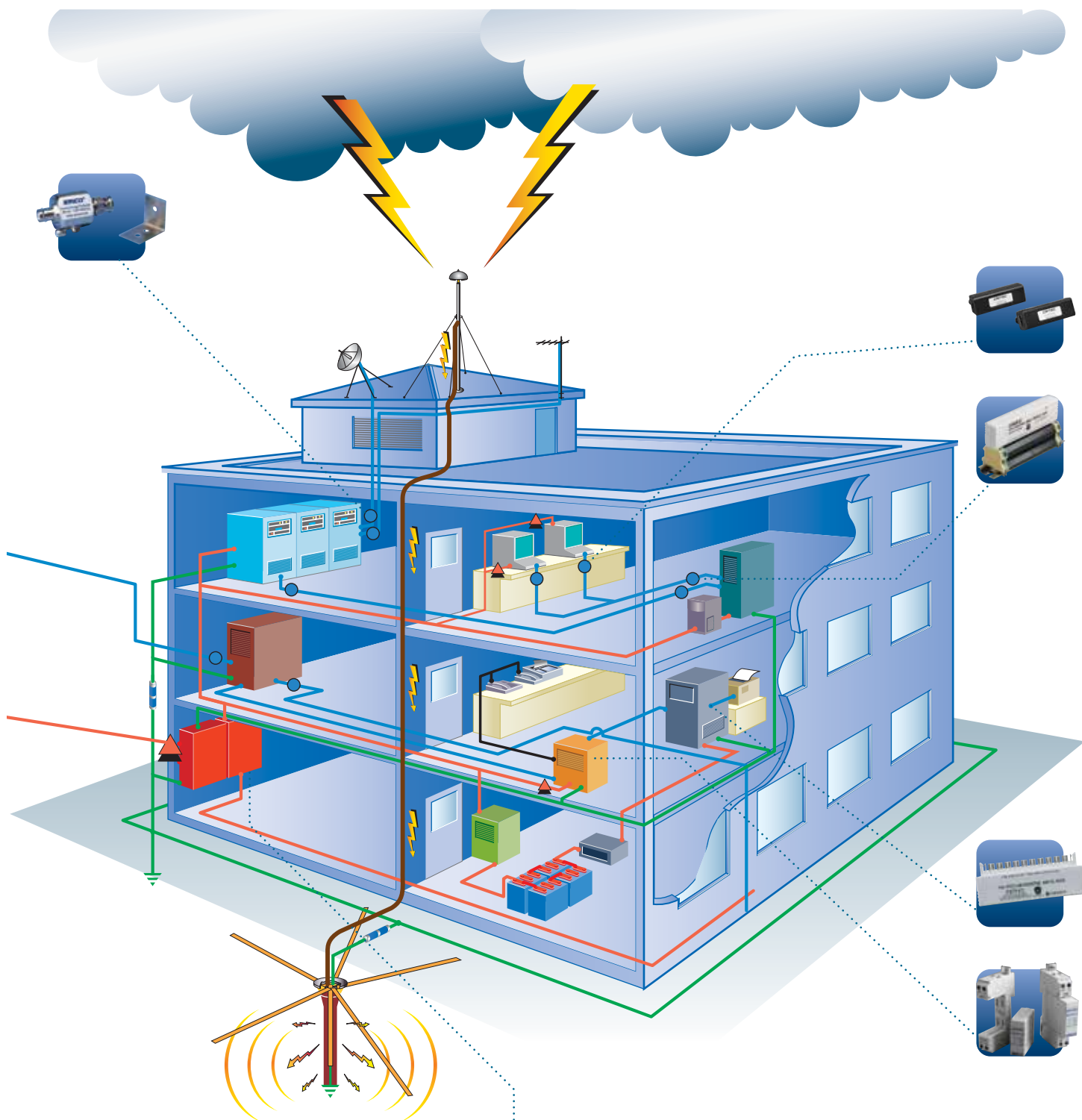

COLOUR CODE

-  Surge Protection Device
-  Telecommunication and Dataline Protection Device
-  Power Line
-  Telecoms and Data
-  Earthing Network



SURGE PROTECTION

SURGE PROTECTION

Dinline Surge Diverters 150kA



Reference code	Part No.	Description		Unit weight kg
DSD11502SR275	702420	150kA, 275V	1	0,33

Dinline Surge Diverters 100-10kA



Reference code	Part No.	Description		Unit weight kg
DSD1601SR275	702460	60kA, 275V, Relay	1	0,12
DSD1601SR275M	702465	60kA, 275V Module	1	0,10
DSD1401S75	702478	40kA, 75V	1	0,12
DSD1401S275	702491	40kA, 275V	1	0,12
DSD1401SR275	702521	40kA, 275V, Relay	1	0,12
DSD140M275	702496	40kA, 275V Module	1	0,10
DSD1401SR440	702530	40kA, 440V, Relay	1	0,12
DSD140M440	702506	40kA, 440V Module	1	0,10
DSD1101S275	702560	10kA, 275V	1	0,12
DSD110M275	702566	10kA, 275V Module	1	0,10

Dinline Surge Diverters Three Phase



Reference code	Part No.	Description		Unit weight kg
DSD340TNC275A	702581	40kA, 275V TN-C, Modular	1	0,4
DSD340TNS275A	702591	40kA, 275V TN-S, Modular	1	0,4
DSD340TT275A	702601	40kA, 275V TT, Modular	1	0,4

Dinline DC Surge Diverters for Solar Application (TDS50)



Reference code	Part No.	Description		Unit weight kg
TDS502BR300DC	TDS502BR300DC	2 Pole, 300V, DC	1	0,240
TDS502BR600DC	TDS502BR600DC	2 Pole, 600V, DC	1	0,240
TDS503BR1000DC	TDS503BR1000DC	3 Pole, 1000V, DC	1	0,354

Dinline Spark Gap Diverter (SGD)



Reference code	Part No.	Description		Unit weight kg
SGD11002SNE	702400	100kA 10/350	1	0,3
SGD1251SRNE	702426	25kA 10/350	1	0,12

Transient Discriminating Filter (TDF)



Reference code	Part No.	Description		Unit weight kg
TDF3A120V	700001	3A, 120V	1	0,35
TDF3A240V	700002	3A, 240V	1	0,35
TDF10A120V	700003	10A, 120V	1	0,75
TDF10A240V	700004	10A, 240V	1	0,75
TDF20A120V	700005	20A, 120V	1	0,8
TDF20A240V	700006	20A, 240V	1	0,8

Dinline Surge Filter (DSF)



Reference code	Part No.	Description		Unit weight kg
DSF6A30V	702090	6A, 30V	1	0,200
DSF6A150V	701000	6A, 150V	1	0,200
DSF6A275V	701030	6A, 275V	1	0,200

SURGE PROTECTION

Transient Panel Surge Protection



Reference code	Part No.	Description		Unit weight kg
TDX100M277/480TT	702428	100kA, 277/480V	1	1,400
TDX200M277/480TT	702429	200kA, 277/480V	1	2,000

Universal Transient Barrier (UTB)



Reference code	Part No.	Description		Unit weight kg
UTB5SP	702861	5V, 1.5A	1	0,100
UTB15SP	702862	15V, 1.5A	1	0,100
UTB30SP	702863	30V, 1.5A	1	0,100
UTB60SP	702864	60V, 1.5A	1	0,100
UTB110SP	702866	110V, 1.5A	1	0,100
UTB5DP	702886	5V, 8A, 2 Pair	1	0,100
UTB15DP	702887	15V, 8A, 2 Pair	1	0,100
UTB30DP	702888	30V, 8A, 2 Pair	1	0,100
UTB60DP	702889	60V, 8A, 2 Pair	1	0,100
UTB110DP	702891	110V, 8A, 2 Pair	1	0,100

Transient Dinline Surge Diverter



Reference code	Part No.	Description		Unit weight kg
TDS1501SR277	702407	50kA, 277V	1	0,120
TDS1501SR560	702408	50kA, 560V	1	0,120
TDS11002SR240	702411	100kA, 240V	1	0,120
TDS11002SR277	702412	100kA, 277V	1	0,120
TDS11002SR560	702413	100kA, 560V	1	0,120
TDS350TNC277	702417	50kA, 277V TNC	1	0,360
TDS350TT277	702418	50kA, 277V TT	1	0,360

Local Area Network Protectors (LAN)



Reference code	Part No.	Description		Unit weight kg
LANRJ45C6	700528	RJ45, CAT6	1	0,120
LANRJ45POE	700529	RJ45, POE	1	0,120
LANRJ45RAK	700531	Rackmount Kit	1	0,820

Telecommunication Protectors (SLP/DLP/DLT)



Reference code	Part No.	Description		Unit weight kg
SLP10K1F	701540	Subscriber line, high speed	1	0,100
HSP10K12	700815	12V, high speed	1	0,100
HSP10K36	700805	36V, high speed	1	0,100
HSP10K72	700850	72V, high speed	1	0,100
HSP10K230	700860	230V, high speed	1	0,100
DLT	702721	2.5mm ² terminal block	1	0,150

Coaxial Protectors - TV And Video



Reference code	Part No.	Description		Unit weight kg
CATVF	702535	Cable TV Protector	1	0,100
CATVHF	700746	Antenna TV Protector HF	1	0,040
CATVMF	702525	Antenna TV Protector	1	0,100
CCTV12	703000	CCTV protector (video)	1	0,200

Coaxial Surge Protectors (CSP)



Reference code	Part No.	Description		Unit weight kg
CSP1BNC90	CSP1BNC90	BNC, 90V	1	0,185
CSP1BNC600	CSP1BNC600	BNC, 600V	1	0,185
CSP1NMF90	CSP1NMF90	NMF, 90V	1	0,196
CSP1NMF600	CSP1NMF600	NMF, 600V	1	0,205
CSP1NB90	CSP1NB90	NB, 90V	1	0,189
CSP1NB600	CSP1NB600	NB, 600V	1	0,220

CADWELD / CADWELD PLUS / CADWELD MULTI

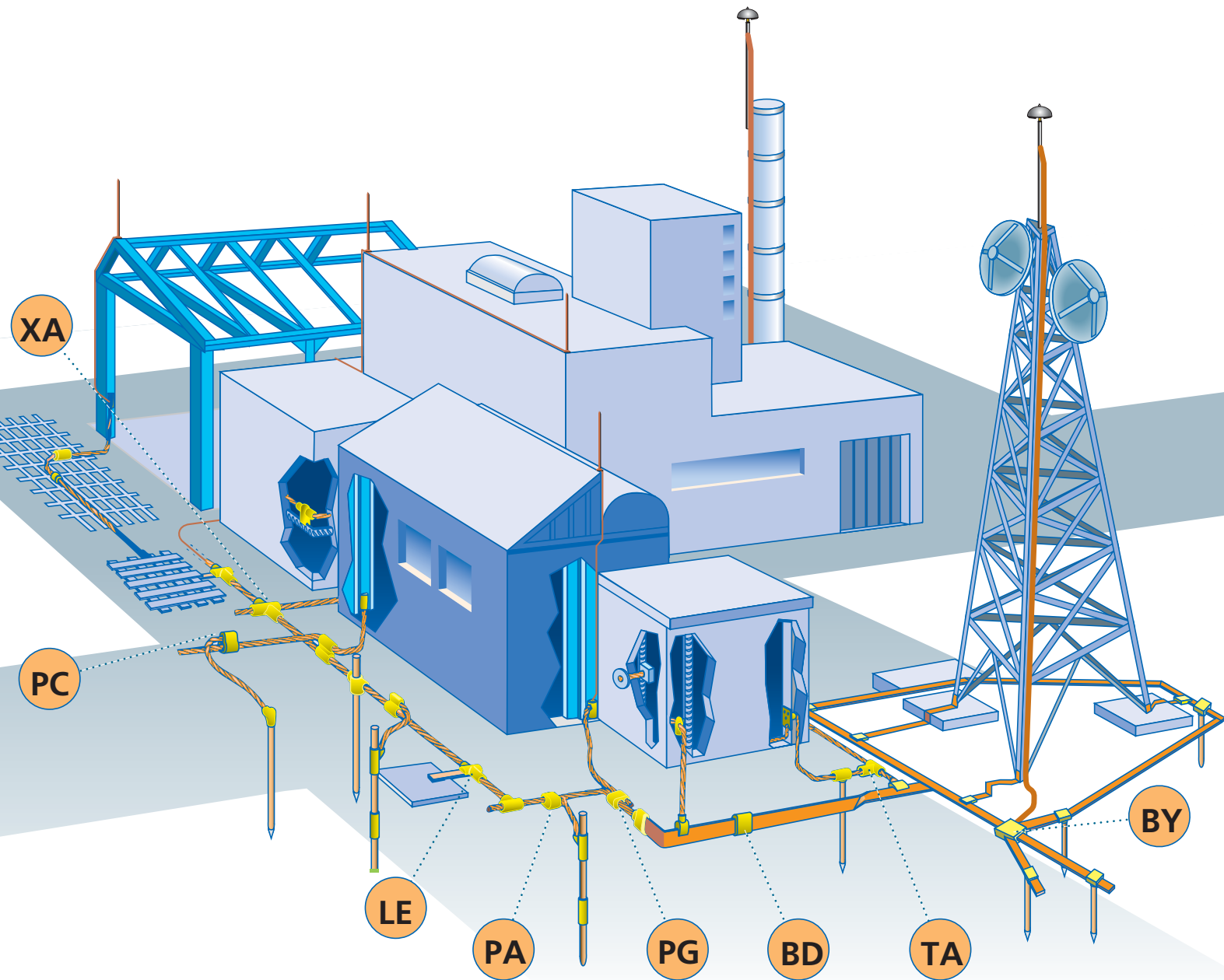

The CADWELD Mould Numbering System

The CADWELD Mould Part Number code gives the complete information of the mould ie:
 - type of connection, mould price key, and conductor size(s).

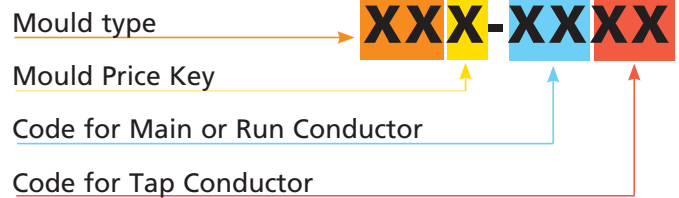

EXAMPLES :

TAC-Y6 Y4

- Type TA
- Price Key C
- 120 mm² Run
- 70 mm² Tap

GTC-P143 Y6

- Type GT
- Price Key C
- 14,2 mm Copper Clad Ground Rod
- 120 mm² Tap

SSC-Y4

- Type SS
- Price Key C
- 2 x 70 mm² cables

VSC-Y2-V76

- Type VS
- Price Key C
- Cable 35 mm²
- Vertical Pipe
- 76 mm Diameter Pipe

CADWELD Wire Size Code Information

Nominal Wire Size*		CADWELD Mould Reference	Number of Strands	Nominal Diameter of Strands (mm)	Nominal Cable Diameter (mm)	Nominal Cable Diameter (inch)	Nominal Strand Area (mm ²)	Nominal Wire Cross Sectional Area (mm ²)
AWG	Cross Sectional Area (mm ²)							
#10	6	1B	7	0.98	2.95	0.12	0.75	5.26
#8		A7	7	1.04	3.12	0.12	0.85	5.95
#6	10	1E	7	1.23	3.71	0.15	1.19	8.32
		W2	7	1.35	4.05	0.16	1.43	10.02
#4	16	1H	7	1.55	4.67	0.18	1.89	13.21
		W3	7	1.70	5.10	0.20	2.27	15.89
#3	25	1L	7	1.96	5.89	0.23	3.02	21.12
		Y1	7	2.14	6.42	0.25	3.60	25.18
#2	25	1Q	7	2.20	6.60	0.26	3.80	26.61
		Y1	19	1.35	6.75	0.27	1.43	27.20
#2 Solid	35	1V	7	2.47	7.42	0.29	4.79	33.54
#1		1T	1	6.54	6.54	0.26	33.62	33.62
		Y2	19	1.53	7.65	0.30	1.84	34.93
#1 Solid	50	1Y	19	1.50	8.43	0.33	1.77	33.58
1/0 Solid		1X	1	7.35	7.35	0.29	42.41	42.41
	1/0	Y3	19	1.78	8.90	0.35	2.49	47.28
2/0 Solid		2B	1	8.25	8.25	0.32	53.49	53.49
	2/0	2C	19	1.89	9.46	0.07	2.81	53.43
3/0		2F	1	9.27	9.27	0.36	67.43	67.43
	4/0 Solid	2G	19	2.13	10.65	0.42	3.56	67.70
4/0		Y4	19	2.14	10.70	0.42	3.60	68.34
	250 KCM	Y5	37	1.78	12.46	0.49	2.49	92.07
300 KCM		Y5	19	2.52	12.60	0.50	4.99	94.76
	350 KCM	2L	19	2.59	12.95	0.47	5.27	100.10
400 KCM		2P	1	11.68	11.68	0.46	107.22	107.22
	500 KCM	2Q	19	2.89	13.41	0.53	6.56	124.63
240		Y6	37	2.03	14.21	0.56	3.24	119.75
	300	2V	37	2.07	14.61	0.58	3.37	124.52
350		Y7	37	2.25	15.75	0.62	3.98	147.11
	400	3A	37	2.29	16.00	0.63	4.12	152.39
450		3D	37	2.47	17.30	0.68	4.79	177.29
	500	Y8	37	2.52	17.64	0.69	4.99	184.54
550		3H	37	2.64	18.49	0.73	5.47	202.53
	600	Y9	61	2.25	20.25	0.80	3.98	242.54
650		3Q	61	2.30	20.65	0.81	4.15	253.44
	700	Y0	61	2.52	22.68	0.89	4.99	304.24

KCM was previously MCM, ie 1000 circular mils, a measure of the wire cross-sectional area.

Note that KCM "overstates" the true cross sectional area (measured in sq. mils) of a conductor by $4/\pi$ (i.e. 1.273)

1 mil = 0.001 inch

Square Inches x 1273 = KCM

Square Millimeters x 1.974 = KCM

KCM x 0.5607 = Square Millimeters

*** Important Note:** Sizes indicated in table are for reference only. Also, compacted versions might exist. Actual wire sizes can vary based on supplier's specifications. Please check cable size when confirming order.

CADWELD PLUS

CADWELD PLUS connections offer all the benefits of conventional CADWELD connections:

- Withstand repeated fault currents without failing during operation
- Exceed requirements of "IEEE® Std 837- Std. for Qualifying Permanent Connections Used In Substation Grounding"
- Join copper to copper, copper to galvanised or plain steel, copper to copper clad steel, copper to bronze/ brass/stainless steel, steel to steel, etc.
- Current carrying capacity equal to or greater than that of the conductor
- Permanent, molecular bond that will not loosen or corrode, resulting in a connection with a lifetime equal to that of the installation
- No external power or heat source required
- Quality assurance inspection is easy and visual
- Minimal installation training required
- Consists of a tamper proof, disposable, moisture-resistant welding material cup. The welding material, disk and ignition source are incorporated into the self-contained package
- Long shelf life
- Completes welds at distances of up to 6 ft/1.8 meters (up to 15 ft/4.6 meters with optional lead)
- Requires minimum components – no starting material, no disks, no flint igniters
- Easy to handle, store and transport – by air, land or sea in unlimited quantities
- Reduces installation time by 20%
- Has electronic ignition with a CE/UL battery powered controller box that is designed for 600 connections with one set of 8 standard AA batteries (included) – requiring no special batteries or chargers
- Designed for use in standard CADWELD moulds including CADWELD MULTI

The ultimate welded connection that will never loosen, corrode or increase in resistance just got **BETTER.**

CADWELD PLUS is the latest advancement in the continuing evolution of ERICO's exothermic products. Since its development in 1938, CADWELD electrical connections have become recognised as the ultimate connection for rail, cathodic, power and grounding applications. ERICO has established itself as the worldwide connections leader. CADWELD PLUS continues this tradition of technical leadership.

The revolutionary CADWELD PLUS system is a simplified method of performing exothermically welded electrical connections. The CADWELD PLUS integrated welding material package has streamlined the installation process by eliminating ignition materials – reducing set up time.

The tamper proof, integrated welding material package consists of a steel cup containing CADWELD patented welding material alloys and ignition source. This new welding material package is designed for use in all standard CADWELD moulds including CADWELD MULTI. Once placed in the CADWELD mould, the welding material is electronically ignited using a simple battery-powered control unit with six (6) foot lead.

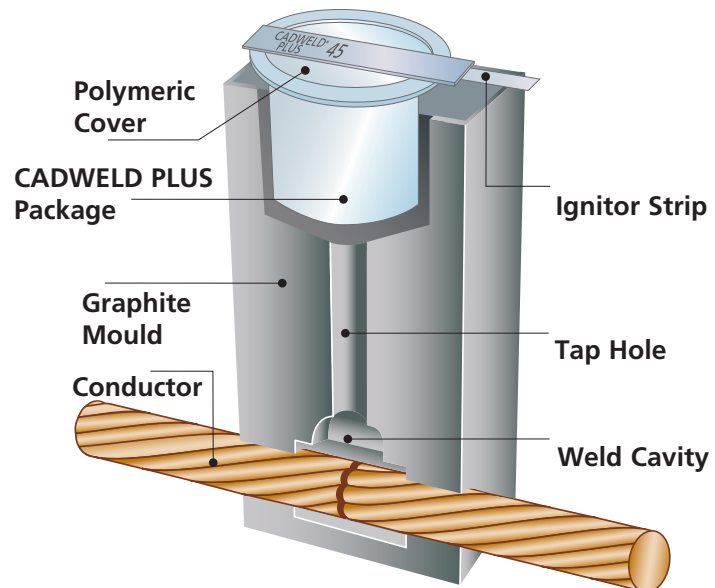

CADWELD PLUS

Feature	Benefits
<i>Integrated Welding Material Package</i>	<ul style="list-style-type: none"> • Simplifies training and set up • Saves labour • Simplifies cleaning
<i>Electronic Control Unit</i>	<ul style="list-style-type: none"> • No starting material required • Easy ignition
<i>Pluggable, Six Foot Control Unit Lead</i>	<ul style="list-style-type: none"> • Increased flexibility in hard to reach areas

CADWELD PLUS

Installation Is Easy!

4 Simple Steps For Permanently Welded Electrical Connections



1 Insert CADWELD PLUS package into mould



2 Attach control unit termination clip to ignition strip



3 Press and hold control unit switch and wait for the ignition



4 Open the mould and remove the expended steel cup – no special disposal required

CADWELD PLUS for Grounding Applications

CADWELD PLUS Reference Code	Part No.	Traditional Welding Material Part Number (Clear Cap)
15PLUSF20	165700	15
25PLUSF20	165701	25
32PLUSF20	165702	32
45PLUSF20	165703	45
65PLUSF20	165704	65
90PLUSF20	165705	90
115PLUSF20	165706	115
150PLUSF20	165707	150
200PLUSF20	165708	200
250PLUSF20	165709	250
300PLUSF20	165710	use 2 x 150
400PLUSF20	165711	use 2 x 200
500PLUSF20	165712	500
600PLUSF20		600
750PLUSF20		750

CADWELD PLUS for Cathodic Applications

CADWELD PLUS Reference Code	Part No.	Traditional Welding Material Part Number (Green Cap)
CA15PLUSF33	165713	CA15/CA15S
CA25PLUSF33	165714	CA25
CA32PLUSF33	165715	CA32
CA45PLUSF33	165716	CA45
CA65PLUSF33	165717	CA65

Gram weight PLUS welding material type i.e. 45PLUSF20



PLUSCU

CADWELD PLUS Patent Numbers
6,553,911 6,835,910 6,703,578

Accessories

Reference Code	Part No.	Description
PLUSCU	165738	CADWELD PLUS Control Unit
PLUSCU15L	165745	CADWELD PLUS Control Unit with 15 ft. (4.6 meters) Lead
PLUSCULDQC	PLUSCULDQC	Pluggable Control Unit Replacement Lead 6 ft. (1.8 meters)
PLUSCULD15QC	PLUSCULD15QC	Pluggable Control Unit Replacement Lead 15 ft. (4.6 meters)



CADWELD PLUS control unit initiates the reaction of the metal crucible. The standard unit includes a 6-foot (1.8 meter) high temperature control unit lead. The lead attaches to the ignition strip using a custom made, purpose-designed termination clip.

After the termination clip is installed on the ignition strip, the installer pushes and holds the ignition button to start a charging and discharging sequence. Within a few seconds the control unit sends a predetermined voltage to the ignition strip and the reaction is initiated.

CADWELD AND CADWELD PLUS

Traditional CADWELD & CADWELD PLUS Welding Material



Welding Material Size	Traditional CADWELD					CADWELD PLUS				
	Reference code	Part No.	 Unit Weight kg	Disk Type*	Reference code	Part No.	 Unit Weight kg			
F20 Alloy - Clear Cap - Copper/Copper - Copper/Steel - Steel/Steel										
15	15	163590	20	0,015	19	15PLUSF20	165700	20	0,049	
25	25	163000	20	0,025	19	25PLUSF20	165701	20	0,063	
32	32	163010	20	0,032	19	32PLUSF20	165702	20	0,065	
45	45	163020	20	0,045	19	45PLUSF20	165703	20	0,086	
65	65	163030	20	0,065	19	65PLUSF20	165704	20	0,104	
90	90	163040	10	0,090	25	90PLUSF20	165705	10	0,158	
115	115	163050	10	0,115	25	115PLUSF20	165706	10	0,185	
150	150	163060	10	0,150	38	150PLUSF20	165707	10	0,217	
200	200	163070	10	0,200	38	200PLUSF20	165708	10	0,267	
250	250	163080	10	0,250	38	250PLUSF20	165709	10	0,353	
300	use (2) 150					300PLUSF20	165710	10	0,376	
400	use (2) 200					400PLUSF20	165711	10	0,480	
500	500	163090	10	0,500	38	500PLUSF20	165712	10	0,585	
600	use (3) 200		10			600PLUSF20		10		
750	use (3) 250		10			750PLUSF20		10		
F33 Alloy - Green Cap - Cathodic protection - Steel pipe										
15	CA15	163200	20	0,015	19	CA15PLUSF33	165713	20	0,049	
25	CA25	163210	20	0,025	19	CA25PLUSF33	165714	20	0,063	
32	CA32	163220	20	0,032	19	CA32PLUSF33	165715	20	0,065	
45	CA45	163230	20	0,045	19	CA45PLUSF33	165716	20	0,086	
65	CA65	163240	20	0,065	19	CA65PLUSF33	165717	20	0,104	
90	CA90	163250	10	0,090	25					
115	CA115	163260	10	0,115	25					
150	CA150	163270	10	0,150	38					

CADWELD Welding Material

CADWELD welding material consists of copper oxide and aluminum, packaged by weight (in grams) in plastic tubes. Each tube contains starting material at the bottom of the plastic tube. Welding material is packaged in containers along with metal disks. Standard welding material (F20) is packaged in tubes with clear caps and is used for all grounding connections with the exception of those to cast iron or rail.

CADWELD PLUS

CADWELD PLUS simplifies the method of making exothermic connections by eliminating the need for starting material or a separate disk. With the CADWELD PLUS control unit, welds can be completed 1.8 m or more than 4 m away.

CADWELD MULTI

4 Easy steps for multiple, permanently welded, electrical connections



Step 1 Layer batting and variable conductor sizes to be welded into dry mould



Step 2 Close mould and drop metal disk in place



Step 3 Deposit welding material and tap bottom of container to release starting material



Step 4 Close the cover and ignite with flint ignitor. Open the mould after 10 seconds



The CADWELD MULTI combines a versatile mold block and a range of gaskets (batting) to allow numerous different welded connections to be produced without the need to change the mould for each connection type.

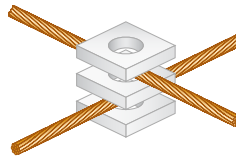

The process is similar to the traditional CADWELD with one distinct difference... there is no need to change the mould for different connection types. The whole process is complete in about one minute. The connection table details the gasket quantities required for each weld.

CADWELD MULTI Available Items

Part Nr	Article Nr	Description	Weight (kg)
KITCDMV01	167782	CADWELD MULTI Kit	1 25.000
The CADWELD MULTI kit (KITCDMV01) contains the following list of items:			
FCDMV01	120883	Handle Clamp	1 1.800
CDMV01H	240399	Mould for H welds	1 1.200
CDMV0112	240398	Mould for welds on 1/2 rods	1 1.200
CDMV0158	240397	Mould for welds on 5/8 rods	1 1.200
CDMV0134	240396	Mould for welds on 3/4 rods*	1 1.200
SCDM01	120886	Set of 33 batting/gaskets	2 0.200
SKK1	162070	SKK1 clamp	1 0.500
TSCSTP	197295	Toolset	1 2.000
B136B	182030	Slag Removal Spade	1 0.144
		Language free instruction sheet	1
The following items can be used with the CADWELD MULTI Kit (KITCDMV01). They are sold separately.			
T320	165000	Flint Ignitor T320	1 0.090
90	163040	CADWELD Traditional welding material	10 0.090
115	163050	CADWELD Traditional welding material	10 0.115
PLUSCU	165738	Control Unit	1 1.088
90PLUSF20	165705	CADWELD PLUS welding material	10 0.158
115PLUSF20	165706	CADWELD PLUS welding material	10 0.185

Due to Pentair's continuous product improvement policy, products shown in this catalog are subject to change without notice. If you would like to know more about the benefits of CADWELD MULTI contact Pentair or visit: www.ericopentair.com

CADWELD MULTI Connection Capabilities

Copper Cable/Solid to Copper Cable/Solid

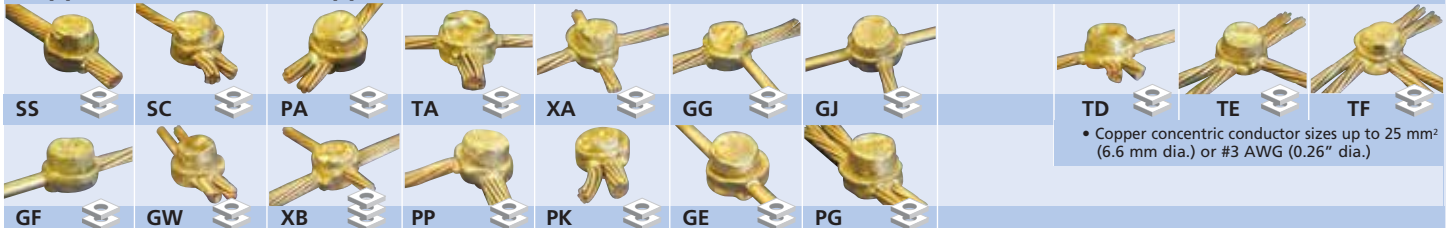

• Copper concentric conductor sizes up to 50 mm² (9.3 mm dia.) or 1/0 AWG (0.37" dia.)

• Copper concentric conductor sizes up to 25 mm² (6.6 mm dia.) or #3 AWG (0.26" dia.)

Copper Cable/Solid Strip to Rebar



• Copper concentric conductor sizes up to 50 mm² (9.3 mm dia.) or 1/0 AWG (0.37" dia.)
 • Copper or steel strip sizes up to 30 x 3,5 mm (1.2" x 0.14")
 • Rebar sizes up to 10 mm (#3)

Copper Strip to Copper Strip



• BB and CG: Copper strip sizes up to 30 x 3,5 mm (1.2" x 0.14")
 • BG and EB: Copper strip sizes up to 30 x 3,0 mm (1.2" x 0.12")

Copper Cable/Solid to Copper or Steel Strip/Lug



• Copper concentric conductor sizes up to 50 mm² (9.3 mm dia.) or 1/0 AWG (0.37" dia.)
 • Copper or steel lug / strip sizes up to 30 x 3,5 mm (1.2" x 0.14")

Galvanised Steel Strip to Galvanised Steel Strip



• Galvanised steel strip sizes up to 30 x 3,5 mm (1.2" x 0.14")

Ground Rod Connections



• Copper concentric conductor sizes up to 10 mm² (4.2 mm dia.) or #6 AWG (0.18" dia.)
 • Copper strip sizes up to 30 x 2,0 mm (1.2" x 0.08")

• Copper concentric conductor sizes greater than 10 mm² (4.2 mm dia.) or #6 AWG (0.18" dia.)
 • Copper strip sizes 30 x (2,5 - 3,0 mm) or 1.2" x (0.10" - 0.12")
 • Steel strip sizes 30 x (0,5 - 3,5 mm) or 1.2" x (0.02" - 0.14")

CADWELD



T393 & T378L
Safety Glasses & Safety Gloves



T313
Card Cleaning Brush



T314
Cable Cleaning Brush



T321
Rasp



B265
Cable Clamp



T111
Surefire™ Torch Head



T403
Mould Sealer

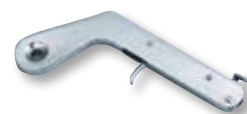

T320
Flint Ignitor

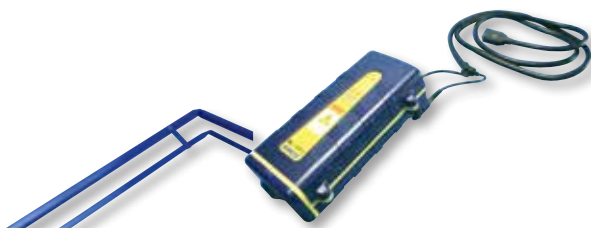

B321-30
Flint Ignitor
Extension

PLUSCU
CADWELD PLUS Control Unit



T394
Mould Cleaning Brush



L160
Handle Clamps



B160V
Chain Support Clamp

M129
Hold Down
Handle
Clamp

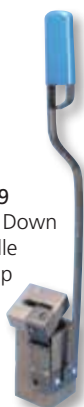

B323N2
Magnet for M129

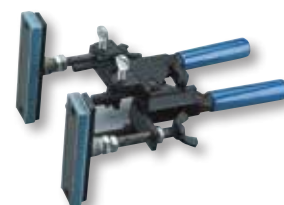

B396
Magnetic Handle Clamp



Battings



Type H
Copper Sleeve



B140
Wrap Sleeve



B136A / B136B
Slag Removal Spade



T306
Ceramic Blanket



T304
Pliers



T305
Screwdriver

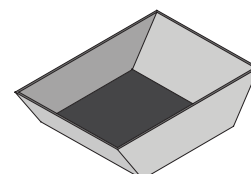

T331
Welding Tray

CADWELD Accessories

Reference Code	Part Number	Description		Weight (kg)
T378L	162422	Gloves	1	0.136
T393	162421	Safety glasses	1	0.068
TSCSTP	197295	Toolset (includes T378L, T313, T384)	1	0.280
T313	165040	Card cleaning brush	1	0.051
T314	165130	Cable cleaning brush	1	0.375
T321C	162630	Rasp	1	0.975
B265	165020	Cable clamp	1	2.386
1120327	140160	Blowlamp	1	0.260
1120330	140180	Cartridge for blowlamp	1	0.100
T111	165170	Torch head Surefire™	1	0.347
T403	165280	CADWELD mould sealer	1	1.030
T320	165000	Flint ignitor	1	0.090
T320A	165010	Spare flints for flint ignitor	10	0.008
B321-30	162429	Flint ignitor extension	1	0.952
PLUSCU	165738	Control unit with 1.80M cable	1	0.907
PLUSCU15L	165745	Control unit with 4.60M cable	1	1.079
PLUSCULDQC	PLUSCULDQC	Pluggable replacement lead 1.80M	1	0.136
PLUSCULD15QC	PLUSCULD15QC	Pluggable replacement lead 4.60M	1	0.318
KIT-120-3/4	165260	Soft brush for mould cleaning	1	0.030
T394	162427	Mould cleaning brush	1	0.066
L160	161000	Handle clamp for 3" wide molds	1	0.911
L159	161020	Handle clamp for 4" wide molds	1	0.991
L161	161010	Handle clamp for 2" wide molds	1	0.380
B134	161740	Frame for L160	1	0.392
B135	161780	Frame for L159	1	0.451
L161A	161090	Vertical handle clamp	1	0.671
L160V	161660	Vertical handle clamp	1	1.775
M129	161030	Hold down handle clamp	1	0.315
B323N2	161630	Magnet for M129	1	0.712
M32	161060	Frame for L160	1	0.880
SMK21	161080	Clamp for RTP mould type	1	0.670
SKK1	162070	Clamp for Positioning (spring clamps)	1	0.500
B159M	161631	Magnetic handle clamp L159 for 4" wide molds	1	3.948
B396	161632	Magnetic handle clamp L160 for 3" wide molds	1	2.700
S2904A	185010	Batting 50 x 60 x 25 mm	25	0.009
S2904B	185020	Batting 50 x 60 x 20 mm	25	0.008
S2904C	185030	Batting 50 x 60 x 12 mm	25	0.005
H101	180140	Copper sleeve Ø 8 x 6 - L 26 mm	50	0.005
H102	180170	Copper sleeve Ø 6,4 x 4,3 - L 25 mm	50	0.004
H103	180180	Copper sleeve Ø 7,7 x 5,3 - L 25 mm	50	0.006
H105	180230	Copper sleeve Ø 5 x 3 - L 23,5 mm	50	0.003
H117	180430	Copper sleeve Ø 9 x 7 - L 25 mm	50	0.006
H111F	180320	Copper sleeve Ø 15 x 13 - L 25 mm	50	0.011
H113F	180360	Copper sleeve Ø 10 x 8 - L 25 mm	50	0.007
B140	165610	Copper wrap sleeve 76 x 25 x 0,20 mm	25	0.010
B136A	182125	Slag removal spade	1	0.045
B136B	182130	Slag removal spade	1	0.100
B136F	182135	Slag removal spade	1	0.087
T396	162436	Toolbox 480 x 220 x 220 mm (metal)	1	3.586
T401	546900	Toolbox 340 x 330 x 270 mm (metal)	1	5.560
T306	162431	Ceramic blanket	1	0.226
T304	162433	Pliers	1	0.167
T305	162434	Screwdriver	1	0.145
T331	162438	Tooltray	1	2.267

Lugs



Part Number	Material	Diameter (mm)	Palm Length (mm)	Overall Length (mm)
B305EGS	Galvanized	17	33	92
B305SS	Stainless Steel	17	33	92
B305TC	Tinned Copper	17	33	92

CADWELD Moulds

A graphite mould is used for making most CADWELD connections. CADWELD molds will generally last an average of 50 or more connections under normal usage.

Price Key and Handle Clamp and/or Frames

- L160 for all molds having a "C", "E", "R" and "Q" mold price key (3" -75 mm -wide moulds)
- L159 for all molds having a "D", "F", "J" and "Z" mold price key (4" -100 mm -wide moulds)

Pictured below are the moulds and / or frames and handles for the various price key moulds:

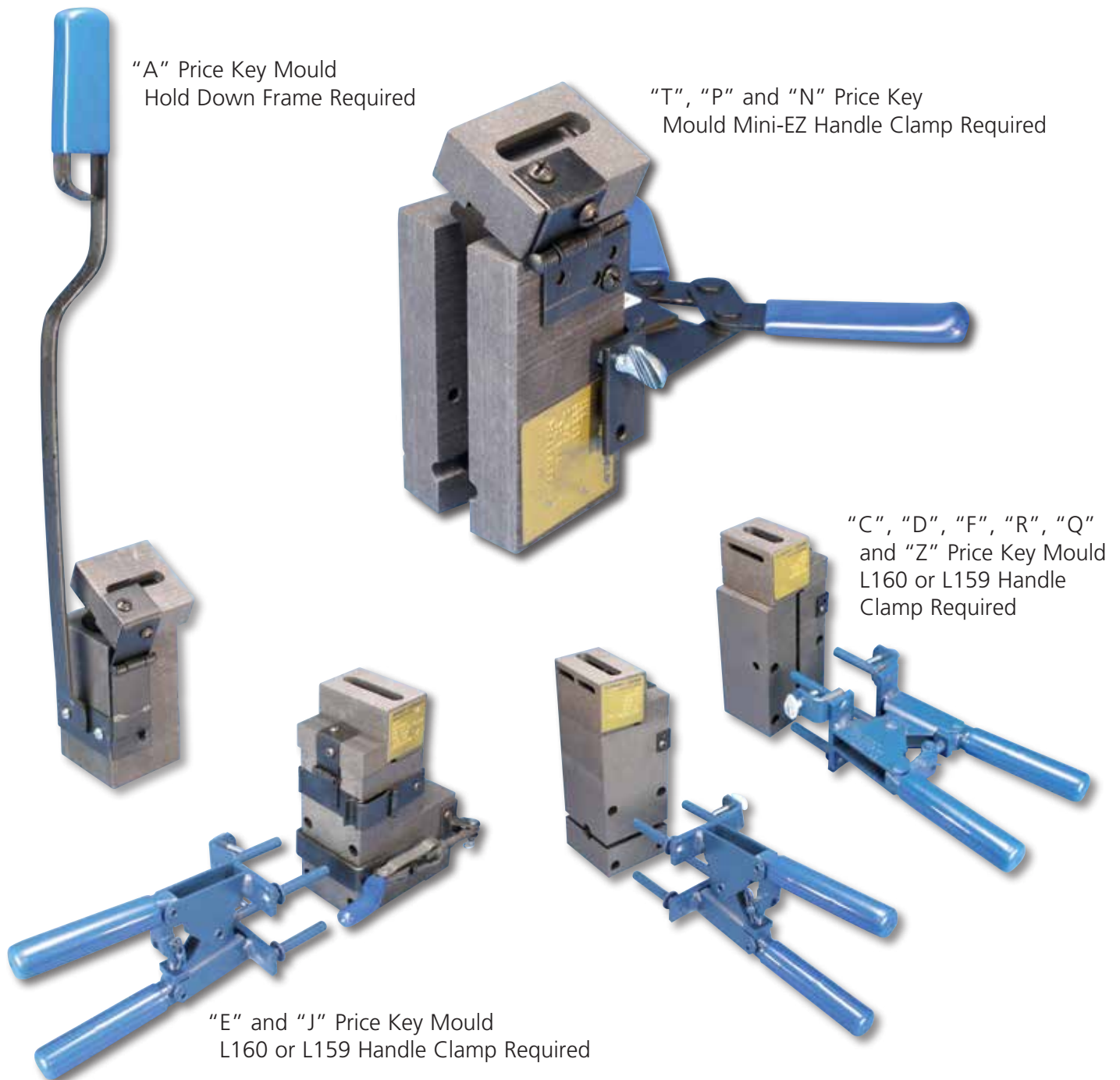

Cable to Cable

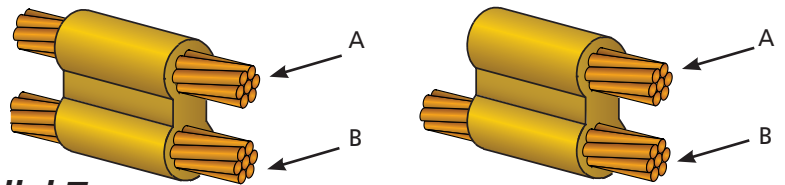

PT - Parallel Horizontal Tee or Parallel Tap

Mould Code	Mould Article Number	Conductor A in mm ²	Conductor B in mm ²	WM Size CADWELD	WM Size CADWELD PLUS	Handle Clamp	Sleeve	Scraper Tool
PTCY1	221268	10	10	45	45PLUSF20	L160	H102	B136A
PTCY2	226545	16	16	65	65PLUSF20	L160	H103	B136A
PTCY1	221268	25	25	45	45PLUSF20	L160		B136A
PTCY2	226545	35	35	65	65PLUSF20	L160		B136A
PTCW6	221267	8 mm solid	8 mm solid	90	90PLUSF20	L160		B136B
PTCY3	221265	50	50	90	90PLUSF20	L160		B136B
PTCY3Y2	PTCY3Y2	50	35	90	90PLUSF20	L160		B136B
PTCW8	PTCW8	10 mm solid	10 mm solid	115	115PLUSF20	L160		B136B
PTCY4	221258	70	70	115	115PLUSF20	L160		B136B
PTCY4Y3	PTCY4Y3	70	50	115	115PLUSF20	L160		B136B
PTCY4Y2	PTCY4Y2	70	35	90	90PLUSF20	L160		B136B
PTCY4Y1	PTCY4Y1	70	25	90	90PLUSF20	L160		B136B
PTCY5	221256	95	95	200	200PLUSF20	L160		B136B
PTCY5Y4	224506	95	70	150	150PLUSF20	L160		B136B
PTCY5Y3	221254	95	50	150	150PLUSF20	L160		B136B
PTCY5Y2	PTCY5Y2	95	35	115	115PLUSF20	L160		B136B
PTCY6Y6	PTCY6Y6	120	120	250	250PLUSF20	L160		B136B
PTCY6Y5	230049	120	95	200	200PLUSF20	L160		B136B
PTCY6Y4	226788	120	70	150	150PLUSF20	L160		B136B
PTCY6Y3	235509	120	50	150	150PLUSF20	L160		B136B
PTCY7Y7	PTCY7Y7	150	150	2 x 150	300PLUSF20	L160		B136B
PTCY7Y6	PTCY7Y6	150	120	250	250PLUSF20	L160		B136B
PTCY7Y5	226221	150	95	200	200PLUSF20	L160		B136B
PTCY7Y4	226222	150	70	150	150PLUSF20	L160		B136B
PTCY8Y8	PTCY8Y8	185	185	2 x 150	300PLUSF20	L160		B136B
PTCY8Y7	PTCY8Y7	185	150	2 x 150	300PLUSF20	L160		B136B
PTCY8Y6	PTCY8Y6	185	120	250	250PLUSF20	L160		B136B
PTCY8Y5	233449	185	95	200	200PLUSF20	L160		B136B
PTDY9Y9	PTDY9Y9	240	240	2 x 200	400PLUSF20	L159		B136B
PTDY9Y8	PTDY9Y8	240	185	2 x 200	400PLUSF20	L159		B136B
PTCY9Y7	PTCY9Y7	240	150	2 x 150	300PLUSF20	L160		B136B
PTCY9Y6	PTCY9Y6	240	120	250	250PLUSF20	L160		B136B

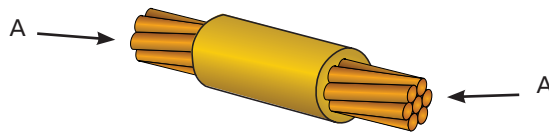

SS - Horizontal Splice

Mould Code	Mould Article Number	Conductor A in mm ²	WM Size CADWELD	WM Size CADWELD PLUS	Handle Clamp	Sleeve	Scraper Tool
SSCY1	SSCY1	10	32	32PLUSF20	L160	H102	B136A
SSCY2	SSCY2	16	32	32PLUSF20	L160	H103	B136A
SSCW3	SSCW3	16	32	32PLUSF20	L160		B136A
SSCY1	SSCY1	25	32	32PLUSF20	L160		B136A
SSCY2	SSCY2	35	32	32PLUSF20	L160		B136A
SSCY3	221009	50	45	45PLUSF20	L160		B136A
SSCW6	221008	8 mm solid	45	45PLUSF20	L160		B136A
SSCY4	221021	70	65	65PLUSF20	L160		B136A
SSCW8	221011	10 mm solid	65	65PLUSF20	L160		B136A
SSCY5	221013	95	90	90PLUSF20	L160		B136B
SSCY6	221014	120	115	115PLUSF20	L160		B136B
SSCY7	221017	150	115	115PLUSF20	L160		B136B
SSCY8	SSCY8	185	150	150PLUSF20	L160		B136B
SSCY9	SSCY9	240	200	200PLUSF20	L160		B136B
SSCY0	SSCY0	300	250	250PLUSF20	L160		B136B

Cable to Cable

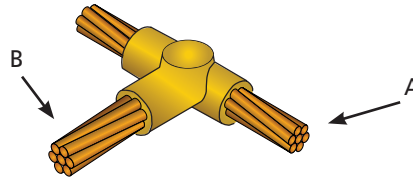

TA - Horizontal Tee

Mould Code	Mould Article Number	Conductor A in mm ²	Conductor B in mm ²	WM Size CADWELD	WM Size CADWELD PLUS	Handle Clamp	Sleeve	Scraper Tool
TACY1Y1	TACY1Y1	10	10	32	32PLUSF20	L160	H102	B136A
TACY2Y2	221028	16	16	45	45PLUSF20	L160	H103	B136A
TACY1Y1	TACY1Y1	25	25	32	32PLUSF20	L160		B136A
TACY2Y2	221028	35	35	45	45PLUSF20	L160		B136A
TACY2Y1	221063	35	25	45	45PLUSF20	L160		B136A
TACY3Y3	222459	50	50	90	90PLUSF20	L160		B136B
TACY3Y2	221071	50	35	65	65PLUSF20	L160		B136A
TACY3Y1	221067	50	25	65	65PLUSF20	L160		B136A
TACY4	221035	70	70	90	90PLUSF20	L160		B136B
TACY4Y3	221077	70	50	90	90PLUSF20	L160		B136B
TACY4Y2	221075	70	35	45	45PLUSF20	L160		B136A
TACY4Y1	221074	70	25	45	45PLUSF20	L160		B136A
TACY5	222461	95	95	115	115PLUSF20	L160		B136B
TACY5Y4	221086	95	70	90	90PLUSF20	L160		B136B
TACY5Y3	221085	95	50	90	90PLUSF20	L160		B136B
TACY5Y2	221084	95	35	90	90PLUSF20	L160		B136B
TACY5Y1	221083	95	25	90	90PLUSF20	L160		B136B
TACY6Y7	TACY6Y7	120	150	200	200PLUSF20	L160		B136B
TACY6Y6	TACY6Y6	120	120	150	150PLUSF20	L160		B136B
TACY6Y5	TACY6Y5	120	95	150	150PLUSF20	L160		B136B
TACY6Y4	221094	120	70	90	90PLUSF20	L160		B136B
TACY6Y3	221093	120	50	90	90PLUSF20	L160		B136B
TACY6Y2	221092	120	35	90	90PLUSF20	L160		B136B
TACY6Y1	224902	120	25	90	90PLUSF20	L160		B136B
TACY7Y7	TACY7Y7	150	150	200	200PLUSF20	L160		B136B
TACY7Y6	TACY7Y6	150	120	150	150PLUSF20	L160		B136B
TACY7Y5	TACY7Y5	150	95	150	150PLUSF20	L160		B136B
TACY7Y4	221098	150	70	90	90PLUSF20	L160		B136B
TACY7Y3	TACY7Y3	150	50	90	90PLUSF20	L160		B136B
TACY7Y2	221096	150	35	90	90PLUSF20	L160		B136B
TACY8Y8	TACY8Y8	185	185	200	200PLUSF20	L160		B136B
TACY8Y7	TACY8Y7	185	150	200	200PLUSF20	L160		B136B
TACY8Y6	TACY8Y6	185	120	200	200PLUSF20	L160		B136B
TACY8Y5	TACY8Y5	185	95	150	150PLUSF20	L160		B136B
TACY8Y4	221107	185	70	115	115PLUSF20	L160		B136B
TACY8Y3	221106	185	50	115	115PLUSF20	L160		B136B
TACY8Y2	221105	185	35	90	90PLUSF20	L160		B136B
TACY9	TACY9	240	240	2 x 150	300PLUSF20	L160		B136B
TACY9Y8	TACY9Y8	240	185	200	200PLUSF20	L160		B136B
TACY9Y7	TACY9Y7	240	150	200	200PLUSF20	L160		B136B
TACY9Y6	TACY9Y6	240	120	200	200PLUSF20	L160		B136B
TACY9Y5	TACY9Y5	240	95	150	150PLUSF20	L160		B136B
TACY9Y4	221115	240	70	115	115PLUSF20	L160		B136B
TACY9Y3	221114	240	50	90	90PLUSF20	L160		B136B
TACY9Y2	TACY9Y2	240	35	90	90PLUSF20	L160		B136B
TADY0Y0	TADY0Y0	300	300	2 x 200	400PLUSF20	L159		B136B
TADY0Y9	TADY0Y9	300	240	2 x 200	400PLUSF20	L159		B136B
TACY0Y8	TACY0Y8	300	185	250	250PLUSF20	L160		B136B
TACY0Y7	TACY0Y7	300	150	200	200PLUSF20	L160		B136B
TACY0Y6	TACY0Y6	300	120	200	200PLUSF20	L160		B136B
TACY0Y5	TACY0Y5	300	95	200	200PLUSF20	L160		B136B
TACY0Y4	TACY0Y4	300	70	150	150PLUSF20	L160		B136B

Cable to Cable

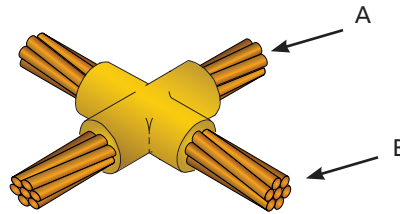

XA - Horizontal Splice

Mould Code	Mould Article Number	Conductor A in mm ²	Conductor B in mm ²	WM Size CADWELD	WM Size CADWELD PLUS	Handle Clamp	Sleeve	Scraper Tool
XACY1	221135	10	10	45	45PLUSF20	L160		B136A
XACY2	221138	16	16	65	65PLUSF20	L160	H102	B136A
XACY1	221135	25	25	45	45PLUSF20	L160		B136A
XACY2	221138	35	35	65	65PLUSF20	L160		B136A
XACY2Y1	XACY2Y1	35	25	65	65PLUSF20	L160		B136A
XACY3	221142	50	50	90	90PLUSF20	L160		B136B
XACY3Y2	221141	50	50	90	90PLUSF20	L160		B136B
XACY3Y1	XACY3Y1	50	35	90	90PLUSF20	L160		B136B
XACW8W8	XACW8W8	10 mm solid	10 mm solid	115	115PLUSF20	L160		B136B
XACY4	221148	70	70	115	115PLUSF20	L160		B136B
XACY4Y3	221147	70	50	115	115PLUSF20	L160		B136B
XACY4Y2	221146	70	35	115	115PLUSF20	L160		B136B
XACY4Y1	XACY4Y1	70	25	115	115PLUSF20	L160		B136B
XACY5Y5	XACY5Y5	95	95	150	150PLUSF20	L160		B136B
XACY5Y4	XACY5Y4	95	70	150	150PLUSF20	L160		B136B
XACY5Y3	XACY5Y3	95	50	150	150PLUSF20	L160		B136B
XACY5Y2	XACY5Y2	95	35	115	115PLUSF20	L160		B136B
XACY6Y6	XACY6Y6	120	120	200	200PLUSF20	L160		B136B
XACY6Y5	XACY6Y5	120	95	200	200PLUSF20	L160		B136B
XACY6Y4	XACY6Y4	120	70	200	200PLUSF20	L160		B136B
XACY6Y3	XACY6Y3	120	50	150	150PLUSF20	L160		B136B
XACY7Y7	XACY7Y7	150	150	250	250PLUSF20	L160		B136B
XACY7Y6	XACY7Y6	150	120	250	250PLUSF20	L160		B136B
XACY7Y5	XACY7Y5	150	95	200	200PLUSF20	L160		B136B
XACY7Y4	XACY7Y4	150	70	200	200PLUSF20	L160		B136B
XACY8Y8	XACY8Y8	185	185	250	250PLUSF20	L160		B136B
XACY8Y7	XACY8Y7	185	150	250	250PLUSF20	L160		B136B
XACY8Y6	XACY8Y6	185	120	250	250PLUSF20	L160		B136B
XACY8Y5	XACY8Y5	185	95	200	200PLUSF20	L160		B136B
XADY9Y9	XADY9Y9	240	240	500	500PLUSF20	L159		B136B
XADY9Y8	XADY9Y8	240	185	2 x 200	400PLUSF20	L159		B136B
XADY9Y7	XADY9Y7	240	150	2 x 200	400PLUSF20	L159		B136B
XADY9Y6	XADY9Y6	240	120	2 x 150	300PLUSF20	L159		B136B

Cable to Cable

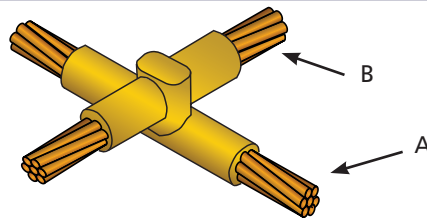

XB - Lapped Horizontal Splice

Mould Code	Mould Article Number	Conductor A in mm ²	Conductor B in mm ²	WM Size CADWELD	WM Size CADWELD PLUS	Handle Clamp	Scraper Tool
XBCY1Y1	XBCY1Y1	25	25	65	65PLUSF20	L160	B136A
XBCY2Y2	230213	35	35	90	90PLUSF20	L160	B136B
XBCY3Y3	230826	50	50	115	115PLUSF20	L160	B136B
XBQY4Y4	XBQY4Y4	70	70	200	200PLUSF20	L160	B136B
XBQY5Y5	XBQY5Y5	95	95	250	250PLUSF20	L160	B136B
XBQY6Y6	XBQY6Y6	120	120	2 x 150	300PLUSF20	L160	B136B
XBZY6Y7	XBZY6Y7	120	150	2 x 200	400PLUSF20	L159	B136B
XBZY7Y7	XBZY7Y7	150	150	2 x 200	400PLUSF20	L159	B136B
XBZY8Y8	XBZY8Y8	185	185	500	500PLUSF20	L159	B136B
XBZY9Y9	XBZY9Y9	240	240	3 x 200	600PLUSF20	L159	B136B

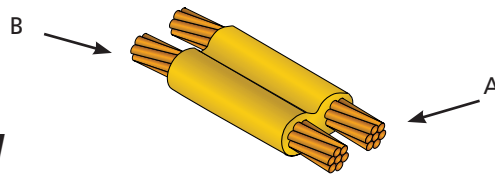

PG - Parallel Horizontal

Mould Code	Mould Article Number	Conductor A in mm ²	Conductor B in mm ²	WM Size CADWELD	WM Size CADWELD PLUS	Handle Clamp	Sleeve	Scraper Tool
PGCY1	237901	10	10	45	45PLUSF20	L160	H102	B136A
PGCY2	232556	16	16	65	65PLUSF20	L160	H103	B136A
PGCY1	237901	25	25	45	45PLUSF20	L160		B136A
PGCY2	232556	35	35	65	65PLUSF20	L160		B136A
PGCY2Y1	239045	35	25	65	65PLUSF20	L160		B136A
PGCY3Y4	237245	70	50	115	115PLUSF20	L160		B136B
PGCY3Y3	PGCY3Y3	50	50	90	90PLUSF20	L160		B136B
PGCY3Y2	233149	50	35	90	90PLUSF20	L160		B136B
PGCY3Y1	238182	50	25	90	90PLUSF20	L160		B136B
PGCY4	231342	70	70	115	115PLUSF20	L160		B136B
PGCY4Y2	237354	70	35	90	90PLUSF20	L160		B136B
PGCY4Y1	236084	70	25	90	90PLUSF20	L160		B136B
PGCY5	223943	95	95	150	150PLUSF20	L160		B136B
PGCY5Y4	236996	95	70	150	150PLUSF20	L160		B136B
PGCY5Y3	235849	95	50	150	150PLUSF20	L160		B136B
PGCY5Y2	233342	95	35	115	115PLUSF20	L160		B136B
PGCY6	231692	120	120	200	200PLUSF20	L160		B136B
PGCY6Y5	238503	120	95	200	200PLUSF20	L160		B136B
PGCY6Y4	PGCY6Y4	120	70	200	200PLUSF20	L160		B136B
PGCY6Y3	235713	120	50	150	150PLUSF20	L160		B136B
PGCY7Y7	PGCY7Y7	150	150	250	250PLUSF20	L160		B136B
PGCY7Y4	PGCY7Y4	150	70	250	250PLUSF20	L160		B136B

Cable to Ground Rods

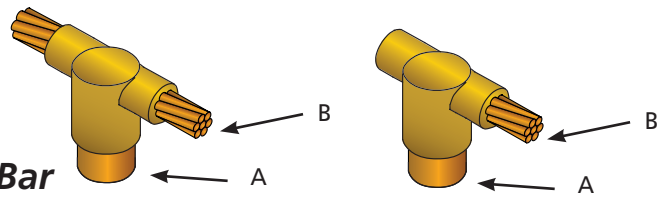

GT - Through Cable to Top of Ground Bar

Mould Code	Mould Article Number	Conductor A Ø in mm	Conductor B in mm ²	WM Size CADWELD	WM Size CADWELD PLUS	Handle Clamp	Scraper Tool
GTC14Y1	GTC14Y1	12.8	25	90	90PLUSF20	L160	B136B
GTC14Y2	GTC14Y2	12.8	35	90	90PLUSF20	L160	B136B
GTC14Y3	GTC14Y3	12.8	50	90	90PLUSF20	L160	B136B
GTC14Y4	GTC14Y4	12.8	70	90	90PLUSF20	L160	B136B
GTC14Y5	GTC14Y5	12.8	95	115	115PLUSF20	L160	B136B
GTC14Y6	GTC14Y6	12.8	120	150	150PLUSF20	L160	B136B
GTC16Y1	GTC16Y1	14.3	25	90	90PLUSF20	L160	B136B
GTC16Y2	GTC16Y2	14.3	35	90	90PLUSF20	L160	B136B
GTC16Y3	GTC16Y3	14.3	50	90	90PLUSF20	L160	B136B
GTC16Y4	GTC16Y4	14.3	70	115	115PLUSF20	L160	B136B
GTC16Y5	GTC16Y5	14.3	95	115	115PLUSF20	L160	B136B
GTC16Y6	GTC16Y6	14.3	120	150	150PLUSF20	L160	B136B
GTC16Y7	GTC16Y7	14.3	150	200	200PLUSF20	L160	B136B
GTC16Y8	GTC16Y8	14.3	185	200	200PLUSF20	L160	B136B
GTC16Y9	GTC16Y9	14.3	240	250	250PLUSF20	L160	B136B
GTC16Y0	GTC16Y0	14.3	300	20 x 150	300PLUSF20	L160	B136B
GTC18Y1	GTC18Y1	17.3	25	90	90PLUSF20	L160	B136B
GTC18Y2	GTC18Y2	17.3	35	90	90PLUSF20	L160	B136B
GTC18Y3	GTC18Y3	17.3	50	90	90PLUSF20	L160	B136B
GTC18Y4	GTC18Y4	17.3	70	115	115PLUSF20	L160	B136B
GTC18Y5	GTC18Y5	17.3	95	115	115PLUSF20	L160	B136B
GTC18Y6	GTC18Y6	17.3	120	150	150PLUSF20	L160	B136B
GTC18Y7	GTC18Y7	17.3	150	200	200PLUSF20	L160	B136B
GTC18Y8	GTC18Y8	17.3	185	200	200PLUSF20	L160	B136B
GTC18Y9	GTC18Y9	17.3	240	250	250PLUSF20	L160	B136B
GTC18Y0	GTC18Y0	17.3	300	2 x 150	300PLUSF20	L160	B136B

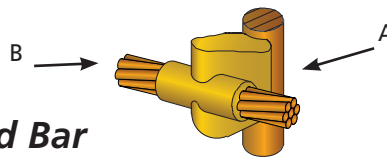

GY - Through Cable to Side of Ground Bar

Mould Code	Mould Article Number	Conductor A Ø in mm	Conductor B in mm ²	WM Size CADWELD	WM Size CADWELD PLUS	Handle Clamp	Scraper Tool
GYE16Y1M	GYE16Y1M	14.3	25	90	90PLUSF20	L160 + M32	B136B
GYE16Y2M	GYE16Y2M	14.3	35	90	90PLUSF20	L160 + M32	B136B
GYE16Y3M	GYE16Y3M	14.3	50	115	115PLUSF20	L160 + M32	B136B
GYE16Y4M	GYE16Y4M	14.3	70	115	115PLUSF20	L160 + M32	B136B
GYE16Y5M	GYE16Y5M	14.3	95	115	115PLUSF20	L160 + M32	B136B
GYE16Y6M	GYE16Y6M	14.3	120	115	115PLUSF20	L160 + M32	B136B
GYE16Y7M	GYE16Y7M	14.3	150	150	150PLUSF20	L160 + M32	B136B
GYE16Y8M	GYE16Y8M	14.3	185	250	250PLUSF20	L160 + M32	B136B
GYJ16Y9M	GYJ16Y9M	14.3	240	2 X 200	400PLUSF20	L159 + M48	B136B
GYE18Y1M	GYE18Y1M	17.3	25	90	90PLUSF20	L160 + M32	B136B
GYE18Y2M	GYE18Y2M	17.3	35	90	90PLUSF20	L160 + M32	B136B
GYE18Y3M	GYE18Y3M	17.3	50	115	115PLUSF20	L160 + M32	B136B
GYE18Y4M	GYE18Y4M	17.3	70	150	150PLUSF20	L160 + M32	B136B
GYE18Y5M	GYE18Y5M	17.3	95	150	150PLUSF20	L160 + M32	B136B
GYE18Y6M	GYE18Y6M	17.3	120	200	200PLUSF20	L160 + M32	B136B
GYE18Y7M	GYE18Y7M	17.3	150	250	250PLUSF20	L160 + M32	B136B
GYJ18Y8M	GYJ18Y8M	17.3	185	2 x 200	400PLUSF20	L159 + M48	B136B
GYJ18Y9M	GYJ18Y9M	17.3	240	500	500PLUSF20	L159 + M48	B136B
GYJ18Y0M	GYJ18Y0M	17.3	300	500	500PLUSF20	L159 + M48	B136B

Busbar to Steel Surface

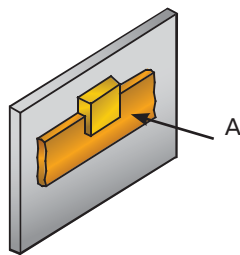

CC - Horizontal on-edge bus run to vertical steel surface

Mould Code	Mould Article Number	Conductor A in mm	WM Size CADWELD	WM Size CADWELD PLUS	Handle Clamp	Scraper Tool
CCPBAK	234734	2 x 30	90	90PLUSF20	L161	B136B

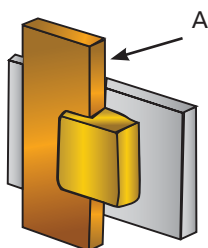

CF - Vertical bus run to vertical steel surface

Mould Code	Mould Article Number	Conductor A in mm	WM Size CADWELD	WM Size CADWELD PLUS	Handle Clamp	Scraper Tool
CFPBAK	232003	2 x 30	65	65PLUSF20	L161	B136A

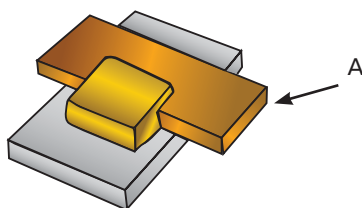

CH - Horizontal bus run to horizontal steel surface

Mould Code	Mould Article Number	Conductor A in mm	WM Size CADWELD	WM Size CADWELD PLUS	Handle Clamp	Scraper Tool
CHPBAK	234733	2 x 30	90	90PLUSF20	L161	B136B

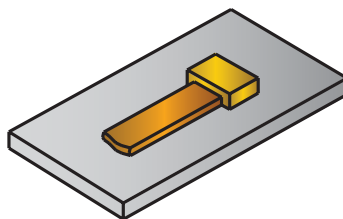

CG - Horizontal

Mould Code	Mould Article Number	Conductor A in mm	WM Size CADWELD	WM Size CADWELD PLUS	Handle Clamp	Scraper Tool
CGPBAK	234732	2 x 30	90	90PLUSF20	L161	B136B

Busbar to Ground Rod

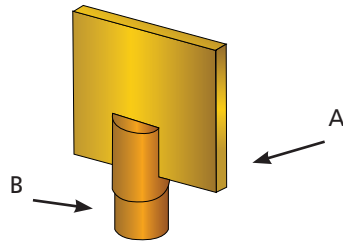

CM - Tee bar on edge

Mould Code	Mould Article Number	Conductor A Ø in mm	Conductor B in mm	WM Size CADWELD	WM Size CADWELD PLUS	Handle Clamp	Scraper Tool
CMC14CAJ	CMC14CAJ	12.8	3 x 25	90	90PLUSF20	L160	B136B
CMC16CAJ	CMC16CAJ	14.3	3 x 25	115	115PLUSF20	L160	B136B
CMC18CAJ	CMC18CAJ	17.3	3 x 25	150	150PLUSF20	L160	B136B

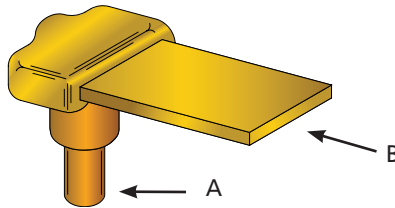

CN - Elbow bar on flat way

Mould Code	Mould Article Number	Conductor A Ø in mm	Conductor B in mm ²	WM Size CADWELD	WM Size CADWELD PLUS	Handle Clamp	Scraper Tool
CNC14CAJ	CNC14CAJ	12.8	3 x 25	90	90PLUSF20	L160	B136B
CNC14CAM	CNC14CAM	12.8	3 x 50	115	115PLUSF20	L160	B136B
CNC16CAJ	CNC16CAJ	14.3	3 x 25	115	115PLUSF20	L160	B136B
CNC16CAM	CNC16CAM	14.3	3 x 50	150	150PLUSF20	L160	B136B
CNC18FAL	CNC18FAL	17.3	5 x 40	200	200PLUSF20	L160	B136B

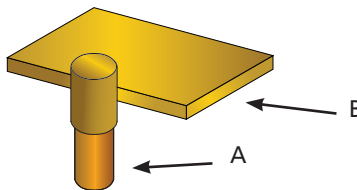

CP - Tee bar on flat way

Mould Code	Mould Article Number	Ground Rod A Ø in mm	Conductor B in mm ²	WM Size CADWELD	WM Size CADWELD PLUS	Handle Clamp	Scraper Tool
CPC16PAJ	CPC16PAJ	14.3	6 x 25	150	150PLUSF20	L160	B136B
CPC18EAL	CPC18EAL	17.3	4 x 40	200	200PLUSF20	L160	B136B

Busbar Connections

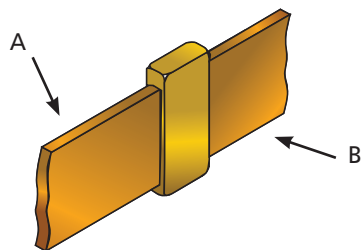

BA - Horizontal busbar connection, on edge

Mould Code	Mould Article Number	Conductor A in mm	Conductor B in mm	WM Size CADWELD	WM Size CADWELD PLUS	Handle Clamp	Scraper Tool
BACCAJ	223521	3 x 25	3 x 25	65	65PLUSF20	L160	B136A
BACEAJ	BACEAJ	4 x 25	4 x 25	65	65PLUSF20	L160	B136B
BACBAK	222120	2 x 30	2 x 30	65	65PLUSF20	L160	B136A
BACCAK	BACCAK	3 x 30	3 x 30	90	90PLUSF20	L160	B136B
BACEAK	BACEAK	4 x 30	4 x 30	115	115PLUSF20	L160	B136B
BACFAK	BACFAK	5 x 30	5 x 30	115	115PLUSF20	L160	B136B
BACCAL	223493	3 x 40	3 x 40	115	115PLUSF20	L160	B136B
BACEAL	223359	4 x 40	4 x 40	150	150PLUSF20	L160	B136B
BACFAL	BACFAL	5 x 40	5 x 40	150	150PLUSF20	L160	B136B
BACPAL	BACPAL	6 x 40	6 x 40	200	200PLUSF20	L160	B136B
BACFAM	BACFAM	5 x 50	5 x 50	250	250PLUSF20	L160	B136B
BACPAM	BACPAM	6 x 50	6 x 50	250	250PLUSF20	L160	B136B

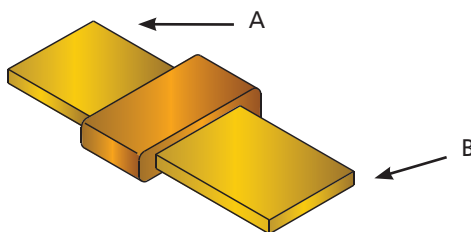

BB - Horizontal busbar connection, on flat way

Mould Code	Mould Article Number	Conductor A in mm	Conductor B in mm	WM Size CADWELD	WM Size CADWELD PLUS	Handle Clamp	Scraper Tool
BBCCAJ	BBCCAJ	3 x 25	3 x 25	90	90PLUSF20	L160	B136A
BBCEAJ	228274	4 x 25	4 x 25	90	90PLUSF20	L160	B136B
BBCEAJ	BBCFAJ	5 x 25	5 x 25	90	90PLUSF20	L160	B136B
BBBCBAK	221640	2 x 30	2 x 30	65	65PLUSF20	L160	B136A
BBCCA	BBCCA	3 x 30	3 x 30	65	65PLUSF20	L160	B136A
BBCEAK	BBCEAK	4 x 30	4 x 30	115	155PLUSF20	L160	B136B
BBCEAK	BBCFAK	5 x 30	5 x 30	115	115PLUSF20	L160	B136B
BBCCAL	221645	3 x 40	3 x 40	90	90PLUSF20	L160	B136B
BBCEAL	BBCEAL	4 x 40	4 x 40	150	150PLUSF20	L160	B136B
BBCEAL	221637	5 x 40	5 x 40	150	150PLUSF20	L160	B136B
BBCEAL	BBCPAL	6 x 40	6 x 40	150	150PLUSF20	L160	B136B
BBDPAMPAM	BBDPAMPAM	6 x 50	6 x 50	250	250PLUSF20	L159	B136B
BBDPAN	BBDPAN	6 x 60	6 x 60	2 x 150	300PLUSF20	L159	B136B

Busbar Connections

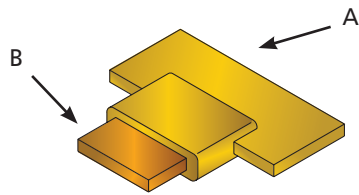

BM - Tee busbar connection, on flat way

Mould Code	Mould Article Number	Conductor A in mm	Conductor B in mm	WM Size CADWELD	WM Size CADWELD PLUS	Handle Clamp	Scraper Tool
BMCCAJCAJ	BMCCAJCAJ	3 x 25	3 x 25	90	90PLUSF20	L160	B136A
BMCEAJEAJ	225287	4 x 25	4 x 25	115	115PLUSF20	L160	B136B
BMCFAJFAJ	222119	5 x 25	5 x 25	115	115PLUSF20	L160	B136B
BMCBKBAK	BMCBKBAK	2 x 30	2 x 30	65	65PLUSF20	L160	B136A
BMCCAQCAK	BMCCAQCAK	3 x 30	3 x 30	65	65PLUSF20	L160	B136A
BMCEAKEAK	221707	4 x 40	4 x 30	90	90PLUSF20	L160	B136B
BMCFAKFAK	221701	5 x 30	5 x 30	115	115PLUSF20	L160	B136B
BMCCALCAL	221706	3 x 40	3 x 40	90	90PLUSF20	L160	B136B
BMCEALEAL	BMCEALEAL	4 x 40	4 x 40	150	150PLUSF20	L160	B136B
BMCFALFAL	BMCFALFAL	5 x 40	5 x 40	150	150PLUSF20	L160	B136B
BMCPALPAL	BMCPALPAL	6 x 40	6 x 40	200	200PLUSF20	L160	B136B
BMDFAMFAM	226839	5 x 50	5 x 50	200	200PLUSF20	L159	B136B
BMDPAMPAM	BMDPAMPAM	6 x 50	6 x 50	250	250PLUSF20	L159	B136B
BMDGAMGAM	BMDGAMGAM	8 x 50	8 x 50	2 x 150	300PLUSF20	L159	B136B
BMDPANPAN	BMDPANPAN	6 x 60	6 x 60	2 x 150	300PLUSF20	L159	B136B

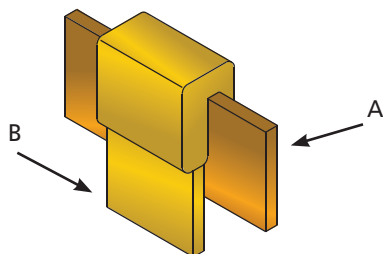

BQ - Tee tap down - horizontal, on-edge busbar

Mould Code	Mould Article Number	Conductor A in mm	Conductor B in mm	WM Size CADWELD	WM Size CADWELD PLUS	Handle Clamp	Scraper Tool
BQCAJCAJ	228210	3 x 25	3 x 25	90	90PLUSF20	L160	B136B
BQCEAJEAJ	BQCEAJEAJ	4 x 25	4 x 25	90	90PLUSF20	L160	B136B
BQCBKBAK	BQCBKBAK	2 x 30	2 x 30	65	65PLUSF20	L160	B136A
BQCCALCAL	228870	3 x 40	3 x 40	115	115PLUSF20	L160	B136B
BQCEALEAL	BQCEALEAL	4 x 40	4 x 40	200	200PLUSF20	L160	B136B
BQCFALFAL	BQCFALFAL	5 x 40	5 x 40	200	200PLUSF20	L160	B136B
BQCPALPAL	BQCPALPAL	6 x 40	6 x 40	250	250PLUSF20	L160	B136B
BQCPAMPAM	BQCPAMPAM	6 x 50	6 x 50	2 x 200	400PLUSF20	L159	B136B
BQDPANPAN	240259	6 x 60	6 x 60	2 x 200	400PLUSF20	L159	B136B

Busbar Connections / Cable to Busbar / Lug

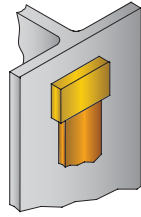

BW - Tee tap down - Vertical, on vertical steel

Mould Code	Mould Article Number	Conductor A in mm	WM Size CADWELD	WM Size CADWELD PLUS	Handle Clamp	Scraper Tool
BWPBAK	239887	2 x 30	65	65PLUSF20	L161	B136A

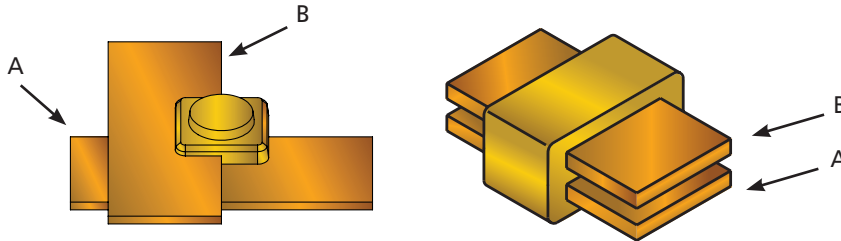

EB - BG - Flat busbar cross connection and flat busbar parallel connection

Mould Code	Mould Article Number	Conductor A in mm	Conductor B in mm	WM Size CADWELD	WM Size CADWELD PLUS	Handle Clamp	Scraper Tool
EBBGPBAK	234398	2 x 30	2 x 30	90	90PLUSF20	L161	B136B

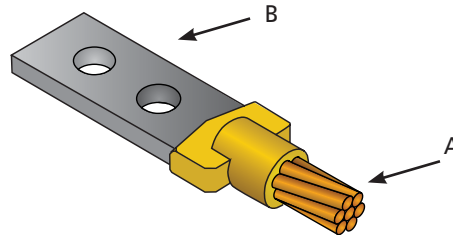

LA - Horizontal cable to horizontal lug

Mould Code	Mould Article Number	Conductor A in mm ²	Conductor B in mm	WM Size CADWELD	WM Size CADWELD PLUS	Handle Clamp	Sleeve	Scraper Tool
LACY1BAH	LACY1BAH	10	2 x 20	32	32PLUSF20	L160	H102	B136A
LACY2BAH	LACY2BAH	16	2 x 20	32	32PLUSF20	L160	H103	B136A
LACY1BAH	LACY1BAH	25	2 x 20	32	32PLUSF20	L160		B136A
LACY2BAH	LACY2BAH	35	2 x 20	32	32PLUSF20	L160		B136A
LACY3BAJ	LACY3BAJ	50	2 x 25	45	45PLUSF20	L160		B136A
LACY3CAJ	221455	50	3 x 25	65	65PLUSF20	L160		B136A
LACY4CAJ	221449	70	3 x 25	65	65PLUSF20	L160		B136A
LACY4EAJ	226114	70	4 x 25	90	90PLUSF20	L160		B136B
LACY5EAJ	LACY5EAJ	95	4 x 25	90	90PLUSF20	L160		B136B
LACY5FAJ	LACY5FAJ	95	5 x 25	90	90PLUSF20	L160		B136B
LACY6FAJ	LACY6FAJ	120	5 x 25	90	90PLUSF20	L160		B136B
LACY6FAK	LACY6FAK	120	5 x 30	90	90PLUSF20	L160		B136B
LACY7FAK	LACY7FAK	150	5 x 30	90	90PLUSF20	L160		B136B
LACY7FAL	LACY7FAL	150	5 x 40	90	90PLUSF20	L160		B136B
LACY8FAL	LACY8FAL	185	5 x 40	150	150PLUSF20	L160		B136B
LACY8FAM	LACY8FAM	185	5 x 50	200	200PLUSF20	L160		B136B
LACY9PAM	240339	240	6 x 50	200	200PLUSF20	L160		B136B
LACY0PAM	240369	300	6 x 50	200	200PLUSF20	L160		B136B

Cable to Busbar / Lug

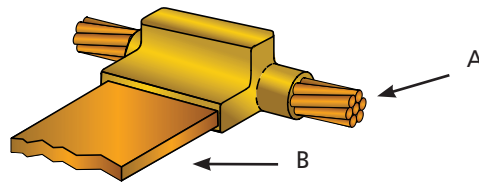

LE - Horizontal cable to flat busbar or lug

Mould Code	Mould Article Number	Conductor A in mm ²	Conductor B in mm	WM Size CADWELD	WM Size CADWELD PLUS	Handle Clamp	Scraper Tool
LECY4CAJ	231112	70	3 x 25	90	90PLUSF20	L160	B136B
LECY4EAJ	232173	70	4 x 25	115	115PLUSF20	L160	B136B
LECY6FAJ	LECY6FAJ	120	5 x 25	150	150PLUSF20	L160	B136B
LECY6FAK	LECY6FAK	120	5 x 30	200	200PLUSF20	L160	B136B
LECY7FAK	LECY7FAK	150	5 x 30	200	200PLUSF20	L160	B136B
LECY8FAL	LECY8FAL	185	5 x 40	250	250PLUSF20	L160	B136B

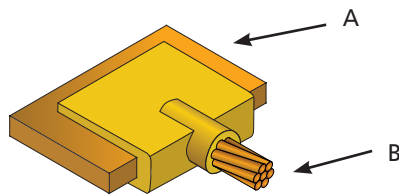

LJ - Cable to bus bar

Mould Code	Mould Article Number	Conductor A in mm ²	Conductor B in mm	WM Size CADWELD	WM Size CADWELD PLUS	Handle Clamp	Scraper Tool
LJCFAMY3	232933	5 X 50	50	90	90PLUSF20	L160	B136B
LJCCAJY3	LJCCAJY3	3 x 25	50	90	90PLUSF20	L160	B136B
LJCCAJY4	LJCCAJY4	3 x 25	70	90	90PLUSF20	L160	B136B
LJCFAMY3	232933	5 x 50	50	90	90PLUSF20	L160	B136B
LJCEAJY4	LJCEAJY4	4 x 25	70	90	90PLUSF20	L160	B136B
LJCEAJY5	LJCEAJY5	4 x 25	95	90	90PLUSF20	L160	B136B
LJCFALY6	LJCFALY6	5 x 40	120	115	115PLUSF20	L160	B136B
LJCFALY7	LJCFALY7	5 x 40	150	115	115PLUSF20	L160	B136B
LJCFAMY8	LJCFAMY8	5 x 50	185	150	150PLUSF20	L160	B136B
LJCPAMY9	LJCPAMY9	6 x 50	240	250	250PLUSF20	L160	B136B
LJCPAMY0	LJCPAMY9	6 x 50	300	2 x 150	300PLUSF20	L160	B136B

Cable to Rebar

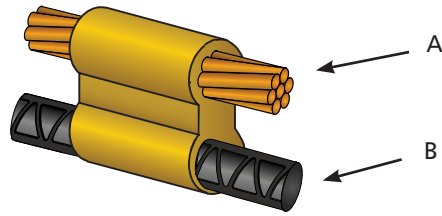

RT - Parallel cable to rebar

Mould Code	Mould Article Number	Conductor A in mm ²	Rebar B in mm	WM Size CADWELD	WM Size CADWELD PLUS	Handle Clamp	Batting	Scraper Tool
RTPY1	234441	25	20 to 40	45	45PLUSF20	SMK21	S2904B	B136A
RTPY2	234444	35	20 to 40	45	45PLUSF20	SMK21	S2904B	B136A
RTPY3	234445	50	20 to 40	90	90PLUSF20	SMK21	S2904B	B136B
RTPY4	234447	70	20 to 40	90	90PLUSF20	SMK21	S2904B	B136B
RTPY5	234453	95	20 to 40	90	90PLUSF20	SMK21	S2904A	B136B
RTPY6	234454	120	20 to 40	115	115PLUSF20	SMK21	S2904A	B136B

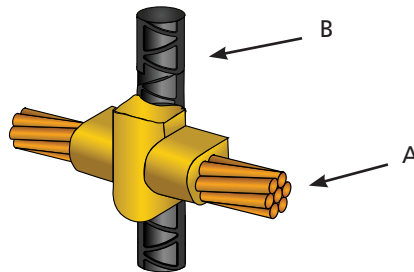

RC - Horizontal cable to vertical rebar

Mould Code	Mould Article Number	Conductor A in mm ²	Rebar B in mm	WM Size CADWELD	WM Size CADWELD PLUS	Handle Clamp	Batting	Scraper Tool
RCPY1	234581	25	20 to 40	45	45PLUSF20	L161A	S2904B	B136A
RCPY2	234585	35	20 to 40	45	45PLUSF20	L161A	S2904B	B136A
RCPY3	234582	50	20 to 40	65	65PLUSF20	L161A	S2904B	B136A
RCPY4	234588	70	20 to 40	90	90PLUSF20	L161A	S2904B	B136B
RCPY5	234592	95	20 to 40	90	90PLUSF20	L161A	S2904B	B136B
RCPY6	234593	120	20 to 40	90	90PLUSF20	L161A	S2904C	B136B

Cable to Steel Surface

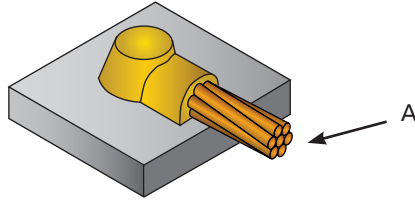

HA - Cable to Horizontal Steel

Mould Code	Mould Article Number	Conductor A in mm ²	WM Size CADWELD	WM Size CADWELD PLUS	Handle Clamp	Sleeve	Scraper Tool
HAA1	221609	10	45	45PLUSF20	M129	H102	B136A
HAA2	221607	16	45	45PLUSF20	M129	H103	B136A
HAA1	221609	25	45	45PLUSF20	M129		B136A
HAA2	221607	35	45	45PLUSF20	M129		B136A
HAA3	221603	50	45	45PLUSF20	M129		B136A
HAA6	221605	8 mm solid	45	45PLUSF20	M129		B136A
HAA4	221534	70	65	65PLUSF20	M129		B136A
HAA8	221602	10 mm solid	65	65PLUSF20	M129		B136A
HAC5	221533	95	90	90PLUSF20	L160		B136B
HAC6	221532	120	115	115PLUSF20	L160		B136B

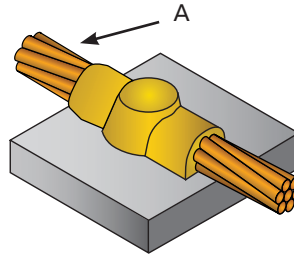

HC - Cable to Horizontal Steel

Mould Code	Mould Article Number	Conductor A in mm ²	WM Size CADWELD	WM Size CADWELD PLUS	Handle Clamp	Sleeve	Scraper Tool
HCA1	224548	10	45	45PLUSF20	M129	H102	B136A
HCA2	227537	16	45	45PLUSF20	M129	H103	B136A
HCA1	224548	25	45	45PLUSF20	M129		B136A
HCA2	227537	35	45	45PLUSF20	M129		B136A
HCA3	HCA3	50	65	65PLUSF20	M129		B136A
HCC4	221279	70	115	115PLUSF20	L160		B136B
HCC5	221278	95	115	115PLUSF20	L160		B136B

Cable to Steel Surface

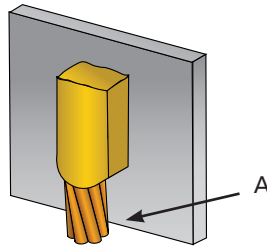

VE - Cable up to vertical steel, tap to steel, cable down

Mould Code	Mould Article Number	Conductor A in mm ²	WM Size CADWELD	WM Size CADWELD PLUS	Handle Clamp	Sleeve	Scraper Tool
VECY1	VECY1	10		45PLUSF20	L160	H102	B136A
VECY2	221623	16		45PLUSF20	L160	H103	B136A
VECY1	VECY1	25		45PLUSF20	L160		B136A
VECY2	221623	35		45PLUSF20	L160		B136A
VECY3	222376	50		65PLUSF20	L160		B136A
VECW6	223370	8 mm solid		90PLUSF20	L160		B136B
VECY4	221620	70		90PLUSF20	L160		B136B
VECY5	222516	95		115PLUSF20	L160		B136B
VECY6	224827	120		115PLUSF20	L160		B136B

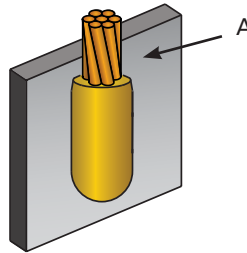

VF - Cable up to steel surface

Mould Code	Mould Article Number	Conductor A in mm ²	WM Size CADWELD	WM Size CADWELD PLUS	Handle Clamp	Sleeve	Scraper Tool
VFCY1	224441	10	65	65PLUSF20	L160	H102	B136A
VFCY2	VFCY2	16	65	65PLUSF20	L160	H103	B136A
VFCY1	224441	25	65	65PLUSF20	L160		B136A
VFCY2	VFCY2	35	65	65PLUSF20	L160		B136A
VFCY3	VFCY3	50	115	115PLUSF20	L160		B136B
VFRY4	221592	70	150	150PLUSF20	L160		B136B
VFRY5	VFRY5	95	200	200PLUSF20	L160		B136B

Cable to Steel Surface

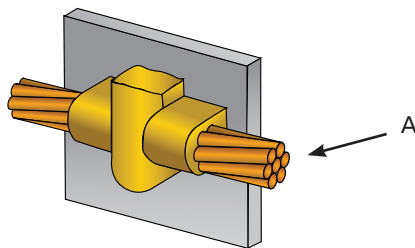

VG - Cable on surface

Mould Code	Mould Article Number	Conductor A in mm ²	WM Size CADWELD	WM Size CADWELD PLUS	Handle Clamp	Sleeve	Scraper Tool
VGPY2M	234506	10	45	45PLUSF20	L161	H102	B136A
VGPY2M	234507	16	65	65PLUSF20	L161	H103	B136A
*VGPY1M	234506	25	45	45PLUSF20	L161	-	B136A
VGPY2M	234507	35	65	65PLUSF20	L161	-	B136A
VGPY3M	234508	50	90	90PLUSF20	L161	-	B136B
VGCY4	228347	70	115	115PLUSF20	L160	-	B136B
VGCY5	223076	95	150	150PLUSF20	L160	-	B136B
VGCY6	223609	120	150	150PLUSF20	L160	-	B136B
VGCY7	240327	150	200	200PLUSF20	L160	-	B136B

* VG Connection for 25 mm² cable is also available as **Compokit CADWELD VGPY1 (168095)**. Compokit CADWELD VGPY1 includes one VGPY1M mold, one L161 handle clamp and one TSCSTP toolset.

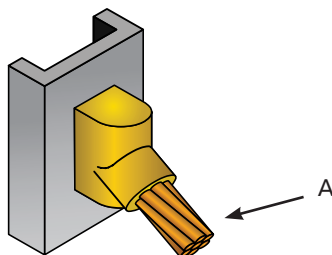

VS - Cable to vertical steel

Mould Code	Mould Article Number	Conductor A in mm ²	WM Size CADWELD	WM Size CADWELD PLUS	Handle Clamp	Sleeve	Scraper Tool
VSCY1	221413	10	45	45PLUSF20	L160	H102	B136A
VSCY2	221410	16	45	45PLUSF20	L160	H103	B136A
VSCY1	221413	25	45	45PLUSF20	L160		B136A
VSCY2	221410	35	45	45PLUSF20	L160		B136A
VSCY3	221407	50	90	90PLUSF20	L160		B136B
VSCY4	221405	70	90	90PLUSF20	L160		B136B
VSCY5	221404	95	115	115PLUSF20	L160		B136B
VSCY6	221403	120	115	115PLUSF20	L160		B136B
VSCY7	VSCY7	150	150	150PLUSF20	L160		B136B
VSCY8	221417	185	200	200PLUSF20	L160		B136B
VSCY9	VSCY9	240	200	200PLUSF20	L160		B136B
VSCY0	VSCY0	300	250	250PLUSF20	L160		B136B

Cable to Steel Surface

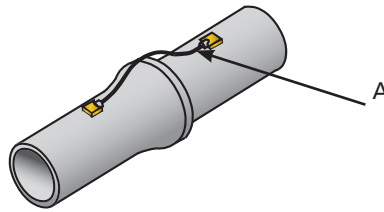

HB - Cable to horizontal steel or cast iron

Mould Code	Mould Article Number	Conductor A in mm ²	WM Size CADWELD	WM Size CADWELD PLUS	Handle Clamp	Sleeve	Scraper Tool
HBAB3	HBAB3	2.5	25 x F19	25PLUSXF19	M129	H105	B136A
HBAB3	HBAB3	4	25 x F19	25PLUSXF19	M129	H105	B136A
HBAB3	HBAB3	6	25 x F19	25PLUSXF19	M129	H105	B136A
HBAB3	HBAB3	16	25 x F19	25PLUSXF19	M129	H105	B136A
HBAY1	221861	10	45 x F19	45PLUSXF19	M129	H102	B136A
HBAY2	221856	16	45 x F19	45PLUSXF19	M129	H103	B136A
HBAY1	221861	25	45 x F19	45PLUSXF19	M129		B136A
HBAY2	221856	35	45 x F19	45PLUSXF19	M129		B136A

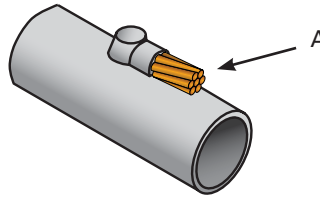

HA-CA - Cable to horizontal steel or cast iron pipe

Mould Code	Mould Article Number	Conductor A in mm ²	WM Size CADWELD	WM Size CADWELD PLUS	Handle Clamp	Sleeve	Scraper Tool
HAAB3CA	HAAB3CA	2.5	CA15	CA15PLUSF33	M129	H105	B136A
HAAB3CA	HAAB3CA	4	CA15	CA15PLUSF33	M129	H105	B136A
HAAB3CA	HAAB3CA	6	CA15	CA15PLUSF33	M129	H105	B136A
HAAB3CA	HAAB3CA	16	CA15	CA15PLUSF33	M129	H105	B136A
HAAD2CA	HAAD2CA	6 mm solid or 10 stranded	CA15	CA15PLUSF33	M129		B136A
HAAW3CA	HAAW3CA	16	CA25	CA25PLUSF33	M129		B136A
HAAY1CA	HAAY1CA	10	CA32	CA32PLUSF33	M129	H102	B136A
HAAY2CA	HAAY2CA	16	CA32	CA32PLUSF33	M129	H103	B136A
HAAY1CA	HAAY1CA	25	CA32	CA32PLUSF33	M129		B136A
HAAY2CA	HAAY2CA	35	CA32	CA32PLUSF33	M129		B136A
HAAY3CA	HAAY3CA	50	CA45	CA45PLUSF33	M129		B136A

Note:

When making connections to steel pipe, the mould must be adapted to the round steel surface. This is done by adding a letter-code suffix to the mould type.

O.D. in mm	Suffix	O.D. in mm	Suffix	O.D. in mm	Suffix
60 to 70	A	135 to 145	D	300 to 350	M
70 to 90	B	145 to 165	E	350 to 450	N
90 to 105	G	165 to 190	J	450 to 550	O
105 to 115	C	190 to 220	F	550 to 700	P
115 to 125	R	220 to 250	K	700 to 1000	Q
125 to 135	H	250 to 300	L	1000 and >1000	--

Example:

Type HA, 25 mm² copper stranded cable to steel pipe O.D. 100 mm → mold required HAAY1GCA

Notice:

In some cases, a larger mold might be required when welding on pipe instead of on a flat surface.

CADWELD Beyond the Standard

Check-List for Defining Your Connection

If you have been unable to find a standard product which meets your requirements photocopy this page, complete the check-list below, and send to your local Pentair representative.

Our technical advisers will suggest a solution.

Connection Type:

- Horizontal
 Vertical
 Other
(provide drawing)

Number of Connections to be Made:

- Construction Reconstruction
 Exterior Interior Buried
 Embedded in concrete On a facade Other _____

Conductor A

- Multi-strand cable Cross-section _____ mm²
 Solid round Ø _____ mm²
 Metal strip Dimensions _____ x _____ mm
 Braid Size _____ Copper
 _____ Steel

Conductor B

- Multi-strand cable Cross-section _____ mm²
 Solid round Ø _____ mm²
 Metal strip Dimensions _____ x _____ mm
 Braid Size _____ Copper
 _____ Steel

Other Items for Welding

- Earth Rods Ø real _____ Material _____
 Rebar Ø real Ø on rib _____
 IPN metal construction : Thickness : _____ Dimensions : _____
 Steel Cast Iron CU
 Other _____

Your Contact Details

Company _____
Project No _____
Address _____
Contact name _____

Date _____ Tel. _____ E-mail _____

INDEX OF PART NUMBERS IN NUMERICAL ORDER

Part No.	Reference code	Page	Part No.	Reference code	Page	Part No.	Reference code	Page
101100	CPD2440	41	107610	STBF-40-GS	39	158500	EGRD58	38
101230	CTR10	29	107650	SFT23N	28	158510	EGRD58L	38
101260	CCR68CU	29	107660	SFTP23N	28	158520	EGRD34	38
101265	CCR68GS	29	120319	MPSC4045S	38	158530	EGRD34L	38
101700	ASL240CC	23	120883	FMCDMV01	53	158540	15SS20	37
101900	ARC2205CNC	24	120886	SCDM01	53	158550	DTP1120SS	37
101910	ARC2210CNC	24	140160	1120327	55	158610	PT1225/300	36
101920	ER12000	23	140180	1120330	55	158675	PT5825/300	36
101925	ER1ARCCSS	19	155000	1,2M38	35	158690	PT5835/300	36
101930	ER22000	23	155010	1,5M38	35	158760	1,0CG50/3	37
101940	ER32000	23	155030	2,1M38	35	158770	1,5CG50/3	37
101950	TFS 800	23	155050	3,0M38	35	158780	2,0CG50/3	37
102000	ARC2205SS	24	155060	1,2M12	35	158810	1,5SG20	37
102010	ARC2210SS	24	155070	1,5M12	35	158922	WGRS200	39
102350	ASBTCA	24	155090	2,1M12	35	161000	L160	55
102400	ASP100TS	24	155110	3,0M12	35	161010	L161	55
102410	ASATB	24	155240	1,2M58	35	161020	L159	55
102450	ABFF6530TC	24	155250	1,5M58	35	161030	M129	55
102460	ABFR6530TC	24	155270	2,1M58	35	161060	M32	55
102500	ASFR	24	155290	3,0M58	35	161080	SMK21	55
102600	ATR105S	25	155300	S1,2M58	35	161090	L161A	55
102610	ACB105S	25	155310	S1,5M58	35	161630	B323N2	55
102620	AEM105S	25	155330	S2,1M58	35	161631	B159M	55
102700	CCJ70CA	27	155350	S3,0M58	35	161632	B396	55
102800	PCF40GS	27	155420	1,2M34	35	161660	L160V	55
102850	PCR21GS	27	155430	1,5M34	35	161740	B134	55
103100	ACF2-GS	21, 24	155450	2,1M34	35	161780	B135	55
103450	IP-900-C	39	155470	3,0M34	35	162070	SKK1	53, 55
103470	IP-R193x122MM	39	155480	S1,2M34	35	162421	T393	55
103480	IP-SQ-180-CI	39	155490	S1,5M34	35	162422	T378L	55
103700	SRL23N6	28	155510	S2,1M34	35	162427	T394	55
103710	SRL23N8	28	155530	S3,0M34	35	162429	B321-30	55
103720	SRL23N10	28	156900	C19	38	162431	T306	55
104200	R1SRL25A6	27	156910	C20	38	162433	T304	55
104300	R1SFT25	27	158000	CC12F	35	162434	T305	55
104350	R2SRL25	27	158010	CC58	35	162436	T396	55
104450	R2SFT25	27	158020	CC34	35	162438	T331	55
104600	R3SFT25	28	158040	SC58	35	162630	T321C	55
104950	R6SRL40/6	28	158050	SC34	35	163000	25	52
104980	R6SFT40	28	158060	DT12	35	163010	32	52
105300	T1SRL25/6	28	158070	DT58	35	163020	45	52
105400	T1SFT25	28	158080	DT34	35	163030	65	52
106010	SFRBE8	29	158100	DS58	35	163040	90	52, 53
106030	SFRBC8	29	158110	DS34	35	163050	115	52, 53
106060	SFTBE	29	158120	DH12	35	163060	150	52
106080	SFTBC	29	158130	DH58	35	163070	200	52
106200	SFRRSRL45/6	28	158140	DH34	35	163080	250	52
106300	SFRRSFT45	28	158155	CP38	38	163090	500	52
106310	SFRRSFT65	28	158160	C58	38	163200	CA15	52
107000	SPC5080S	40	158165	CP58	38	163210	CA25	52
107010	SPC70120S	40	158170	C34	38	163220	CA32	52
107020	SPC130180S	40	158175	CP34	38	163230	CA45	52
107050	SPC5080C	40	158185	SP58	38	163240	CA65	52
107060	SPC70120C	40	158250	C1	38	163250	CA90	52
107070	SPC130180C	40	158260	C12	38	163260	CA115	52
107230	SGR6102	40	158290	PT5850/300	36	163270	CA150	52
107500	SDH3GI	27	158380	DHTR167	37	163590	15	52
107550	SSF-6-GS	39	158400	DTP137120	37	163670	GEM25A	36
107560	SSF-6-C	39	158410	RTC1626	38	165000	T320	53, 55
107600	STBF-25-GS	39	158440	S13620	38	165010	T320A	55

INDEX OF PART NUMBERS IN NUMERICAL ORDER

Part No.	Reference code	Page	Part No.	Reference code	Page	Part No.	Reference code	Page
165020	B265	55	180140	H101	55	221067	TACY3Y1	58
165040	T313	55	180170	H102	55	221071	TACY3Y2	58
165130	T314	55	180180	H103	55	221074	TACY4Y1	58
165170	T111	55	180230	H105	55	221075	TACY4Y2	58
165180	B165	42	180320	H111F	55	221077	TACY4Y3	58
165220	B166	42	180360	H113F	55	221083	TACY5Y1	58
165230	B167	42	180430	H117	55	221084	TACY5Y2	58
165260	KIT-120-3/4	55	182030	B136B	53	221085	TACY5Y3	58
165280	T403	55	182125	B136A	55	221086	TACY5Y4	58
165400	B2618B	41	182130	B136B	55	221092	TACY6Y2	58
165410	B2610A	41	182135	B136F	55	221093	TACY6Y3	58
165610	B140	55	185010	S2904A	55	221094	TACY6Y4	58
165620	B2617A	41	185020	S2904B	55	221096	TACY7Y2	58
165700	15PLUSF20	51, 52	185030	S2904C	55	221098	TACY7Y4	58
165701	25PLUSF20	51, 52	197295	TSCSTP	53, 55	221105	TACY8Y2	58
165702	32PLUSF20	51, 52	197650	TCEC302030	30	221106	TACY8Y3	58
165703	45PLUSF20	51, 52	197710	TCECT302030	30	221107	TACY8Y4	58
165704	65PLUSF20	51, 52	197720	TCECT253030	30	221114	TACY9Y3	58
165705	90PLUSF20	51, 52, 53	197810	30TCHGSP3035	32	221115	TACY9Y4	58
165706	115PLUSF20	51, 52, 53	197860	RSCC8	32	221135	XACY1	59
165707	150PLUSF20	51, 52	197870	RSCC10	32	221138	XACY2	59
165708	200PLUSF20	51, 52	197900	SCEC25	30	221141	XACY3Y2	59
165709	250PLUSF20	51, 52	197910	SCEC35	30	221142	XACY3	59
165710	300PLUSF20	51, 52	197920	SCEC50	30	221146	XACY4Y2	59
165711	400PLUSF20	51, 52	197930	SCEC70	30	221147	XACY4Y3	59
165712	500PLUSF20	51, 52	197940	SCEC95	30	221148	XACY4	59
165713	CA15PLUSF33	51, 52	197950	SCEC185	30	221254	PTCY5Y3	57
165714	CA25PLUSF33	51, 52	197970	TCECT403030	30	221256	PTCY5	57
165715	CA32PLUSF33	51, 52	197975	TCECT404035	30	221258	PTCY4	57
165716	CA45PLUSF33	51, 52	198000	ICEC25	30	221265	PTCY3	57
165717	CA65PLUSF33	51, 52	198010	ICEC35	30	221267	PTCW6	57
165738	PLUSCU	51, 53, 55	198020	ICEC50	30	221268	PTCY1	57
165745	PLUSCU15L	51, 55	198050	ICECH25	30	221278	HCCY5	69
166030	B161-10B	43	198060	ICECH35	30	221279	HCCY4	69
166040	B161-10KA	44	198150	RCEC6	31	221403	VSCY6	71
166050	B161-10KM	44	198160	RCEC8	31	221404	VSCY5	71
166060	B164-12A	43	198200	RCET6	31	221405	VSCY4	71
166070	B164-12K	44	198210	RCET8	31	221407	VSCY3	71
166080	B164-12KS	44	198250	RAW8	32	221410	VSCY2	71
166120	DB-10A	43	198400	A822SA111C5	41	221413	VSCY1	71
166130	DB-10K	44	198401	FC073	41	221417	VSCY8	71
166140	DB10KS	44	198402	FC074	41	221449	LACY4CAJ	66
166150	DB12A	43	198403	FC075	41	221455	LACY3CAJ	66
166160	DB-12K	44	198404	FC076	41	221532	HACY6	69
166170	DB-12KS	44	198406	FC078	41	221533	HACY5	69
166180	DB-16A	43	198407	FC079	41	221534	HAAY4	69
166190	DB-16K	44	198408	FC080	41	221592	VFRY4	70
166200	DB-16KS	44	198410	A822SA111C10	41	221602	HAAW8	69
166480	DB-10-C5005	44	198411	FC082	41	221603	HAAY3	69
166490	DB-10-C501	44	198420	A822SA111C20	41	221605	HAAW6	69
166500	DB-10-C502	44	221008	SSCW6	57	221607	HAAY2	69
166510	B161-10-C5005	44	221009	SSCY3	57	221609	HAAY1	69
166520	B161-10-C501	44	221011	SSCW8	57	221620	VECY4	70
166530	B161-10-C502	44	221013	SSCY5	57	221623	VECY2	70
167782	KITCDMV01	53	221014	SSCY6	57	221637	BBCFAL	64
167900	SRGBC120	31	221017	SSCY7	57	221640	BBCBAK	64
167901	SRGBD100	31	221021	SSCY4	57	221645	BBCCAL	64
167902	SRGBE100	31	221028	TACY2Y2	58	221701	BMCFAKFAK	65
167903	SRGBF100	31	221035	TACY4	58	221706	BMCCALCAL	65
167904	SRGBG100	31	221063	TACY2Y1	58	221707	BMCEAKEAK	65

INDEX OF PART NUMBERS IN NUMERICAL ORDER

Part No.	Reference code	Page	Part No.	Reference code	Page	Part No.	Reference code	Page
221856	HBAY2	72	234593	RCPY6	68	635880	635880	35
221861	HBAY1	72	234732	CGPBAK	62	700001	TDF3A120V	46
222119	BMCFAJFAJ	65	234733	CHPBAK	62	700002	TDF3A240V	46
222120	BACBAK	64	234734	CCPBAK	62	700003	TDF10A120V	46
222376	VECY3	70	235509	PTCY6Y3	57	700004	TDF10A240V	46
222459	TACY3Y3	58	235713	PGCY6Y3	60	700005	TDF20A120V	46
222461	TACY5	58	235849	PGCY5Y3	60	700006	TDF20A240V	46
222516	VECY5	70	236084	PGCY4Y1	60	700528	LANRJ45C6	47
223076	VGCY5	71	236996	PGCY5Y4	60	700529	LANRJ45POE	47
223359	BACEAL	64	237245	PGCY3Y4	60	700531	LANRJ45RAK	47
223370	VECW6	70	237354	PGCY4Y2	60	700746	CATVHF	47
223493	BACCAL	64	237901	PGCY1	60	700805	HSP10K36	47
223521	BACCAJ	64	238182	PGCY3Y1	60	700815	HSP10K12	47
223609	VGCY6	71	238503	PGCY6Y5	60	700850	HSP10K72	47
223943	PGCY5	60	239045	PGCY2Y1	60	700860	HSP10K230	47
224441	VFCY1	70	239887	BWPBAK	66	701000	DSF6A150V	46
224506	PTCY5Y4	57	240259	BQDPANPAN	65	701030	DSF6A275V	46
224548	HCAY1	69	240327	VGCY7	71	701280	GUYRING	19
224827	VECY6	70	240339	LACY9PAM	66	701305	GUYKIT 4MGRIP	19
224902	TACY6Y1	58	240369	LACY0PAM	66	701315	GUYKIT 7MGRIP	19
225287	BMCEAJEAJ	65	240396	CDMV0134	53	701320	I/LCOUPL	18
226114	LACY4EAJ	66	240397	CDMV0158	53	701340	MBMAST4M	18
226221	PTCY7Y5	57	240398	CDMV0112	53	701350	MBMAST5M	18
226222	PTCY7Y4	57	240399	CDMV01H	53	701360	MBMAST6M	18
226545	PTCY2	57	400680	2HPS	21	701370	ALUM 4M	18
226788	PTCY6Y4	57	502000	ALUM 3ME	18	701380	ALUM 5M	18
226839	BMDFAMFAM	65	502040	MBMAST3ME	18	701390	ALUM 6M	18
227537	HCAY2	69	503900	GF-302	39	701410	CONSAD/FX	19, 21
228210	BQCCAJCAJ	65	504500	WM32088B	31	701420	CABTIESS	19, 21
228274	BBCEAJ	64	504510	WM21030B	31	701460	UBOLT	18
228347	VGCY4	71	504520	WM31020B	31	701535	SI25	19
228870	BQCCALCAL	65	504530	WM21020B	31	701536	SI40	19
230049	PTCY6Y5	57	504540	WMS1030B	31	701537	SI60	19
230213	XBCY2Y2	60	504550	PC2.1020	31	701540	SLP10K1F	47
230826	XBCY3Y3	60	504590	PC30909	31	701840	THERMLUGCOUPL	19
231112	LECY4CAJ	67	545000	DLUNI	40	701875	ERICORE/PER M	18
231342	PGCY4	60	545010	SEB06	40	701895	ERICORE/TRM/IS	18
231692	PGCY6	60	545020	SEB06DL	40	701915	ERICORE/TRM/OS	18
232003	CFPBAK	62	545030	SEB10	40	701990	CONSAD/E2	19
232173	LECY4EAJ	67	545040	SEB10DL	40	702005	ERICORE/LT KITA	18
232556	PGCY2	60	545130	SEB62DL	40	702030	FRP/2M/BLACK	18
232933	LJCFAMY3	67	545135	BEP25x5x200MM	39	702045	FRP/4.6M/BLACK	18
233149	PGCY3Y2	60	545140	BEP25x5x300MM	39	702050	LECVI	19, 21
233342	PGCY5Y2	60	545170	CCS308	21, 27	702065	7000250S4	18
233449	PTCY8Y5	57	545180	CCG308	27	702085	D/SMKIVSS	18
234398	EBBGPBAK	66	545190	SEP	40	702086	ISOCAP50	21
234441	RTPY1	68	545200	TCECT302075	30	702087	ISOFRP3M	21
234444	RTPY2	68	545210	RCEC83	31	702088	ISOMMB50	21
234445	RTPY3	68	545260	SR	27	702089	INTMKIVSS	18
234447	RTPY4	68	545270	CCFR308	27	702090	DSF6A30V	46
234453	RTPY5	68	545530	BEP25x5x150MM	39	702094	ISODUAL	21
234454	RTPY6	68	546900	T401	55	702165	TMCSS	24
234506	VGPY1M	71	550900	HDB5010	30	702175	ALOF1-GS	21, 24
234507	VGPY2M	71	591080	CEI20	21, 27	702180	LSEB 4554	24
234508	VGPY3M	71	591230	FEI20	21, 27	702230	WPC	24
234581	RCPY1	68	591280	BEI20	27	702240	HSF	29
234582	RCPY3	68	591290	42014	21, 27	702250	R7SFT20	29
234585	RCPY2	68	613480	613480	35	702255	ER11000SS	19
234588	RCPY4	68	615880	615880	35	702260	ER12000SS	19
234592	RCPY5	68	633480	633480	35	702265	ER22000SS	19

INDEX OF PART NUMBERS IN NUMERICAL ORDER

Part No.	Reference code	Page	Part No.	Reference code	Page	Part No.	Reference code	Page
702270	ER23000SS	19	705020	ISODC20	20	710616	CTGN25325	30
702275	ER32000SS	19	705030	ISODC30	20	710620	CTGN25630	30
702280	ER33000SS	19	705040	ISODC40	20	710625	LCT253	30
702285	SGAERIAL302	24	705050	ISODC50	20	710630	CTGN50620	30
702290	ER2BASE	19	710010	SSR16	37	710645	CTGY25325	30
702295	ER3BASE	19	710020	AAR0515	21, 23	710655	CTST25325	30
702296	INTCPTADBUTT	19	710030	CTR8CU	29	710666	CTWH25325	30
702297	INTCPTADF2BSPF	19	710040	CTR8AL	29	710667	CTYGN25325	30
702298	INTCPTADF2NSP	19	710050	TECLP8CU	40	710670	HDB2003	30
702299	INTCPTADM3/4UNC	19	710060	TECLP8AL	40	710680	HDB2503	30
702301	INTCPTADM116UN	19	710070	SCR15	36	710690	HDB2506	30
702306	INTCPTADM16	19	710080	SCR20	36	710700	HDB3806	30
702400	SGD11002SNE	46	710090	CDS15	36, 37	710710	HDB5006	30
702407	TDS1501SR277	47	710100	CDS20	36	710730	THDB5060	31
702408	TDS1501SR560	47	710110	PBD10	36	710740	FAT25350	31
702411	TDS11002SR240	47	710115	SSD10	37	710750	ATBL253	32
702412	TDS11002SR277	47	710120	SPK15	36, 37	710760	ATBN253	32
702413	TDS11002SR560	47	710130	SPK20	36	710770	ATGY253	32
702417	TDS350TNC277	47	710140	EBR58	42	710780	ATST253	32
702418	TDS350TT277	47	710150	EBR34	42	710790	ATWH253	32
702420	DSD11502SR275	46	710160	50010EBOSS	41	710800	SCBL	31
702426	SGD1251SRNE	46	710170	SFO50	42	710810	SCBN	31
702428	TDX100M277/480TT	47	710180	PIT03	39	710820	SCGY	31
702429	TDX200M277/480TT	47	710190	PC1.50606	31	710830	SCST	31
702460	DSD1601SR275	46	710200	PC30606	31	710840	SABL	32
702465	DSD1601SR275M	46	710210	PC1.50909	31	710850	SABN	32
702478	DSD1401S75	46	710220	OXINHIBCOMP	42	710860	SAGY	32
702491	DSD1401S275	46	710230	EML663	31	710870	SAST	32
702496	DSD140M275	46	710240	EML993	31	710900	SCEC120	30
702506	DSD140M440	46	710250	ABBC	40	710920	SCEC150	30
702521	DSD1401SR275	46	710260	BBBC	40	710960	BAT2560	31
702525	CATVMF	47	710290	PFC001	25	710965	BAT5060	31
702530	DSD1401SR440	46	710295	PFA001	25	711010	CAR2015	23
702535	CATVF	47	710300	GBH C	26	711030	AVG3.0	27
702560	DSD1101S275	46	710305	GBH A	26	711040	PC010A	26
702566	DSD110M275	46	710325	RC70	41	711050	AAR0510	23
702581	DSD340TNC275A	46	710335	RC100	41	711060	AAR1010	23
702591	DSD340TNS275A	46	710345	RTC2030	38	711070	AAR1015	21, 23
702601	DSD340TT275A	46	710350	RTC2051	38	711080	CAR0510	23
702721	DLT	47	710355	EK16	41	711090	CAR0515	23
702861	UTB5SP	47	710360	RTC2526	38	711100	CAR1010	23
702862	UTB15SP	47	710365	EK17	41	711110	CAR1015	23
702863	UTB30SP	47	710370	UB16	38	711120	CMPR	23
702864	UTB60SP	47	710380	UB20	38	711130	ATBA10	23
702866	UTB110SP	47	710390	UB25	38	711140	ATBA15	23
702886	UTB5DP	47	710400	GUV16070	38	711150	ATBC10	23
702887	UTB15DP	47	710410	GUV70185	38	711160	ATBC15	23
702888	UTB30DP	47	710420	RCC10	39	711170	RSC115	23
702889	UTB60DP	47	710430	RCC16	39	711180	ABR015	23
702891	UTB110DP	47	710440	SRC15	39	711190	CBR015	23
702900	PEC100	42	710450	SRC20	39	711195	ALDTAP302	28
702901	PEC150	42	710510	TCEC253050	30	711200	TTRA16	23
703000	CCTV12	47	710515	TCEC253025	30	711210	TTRC16	23
705001	ISODC01	20	710535	TCEC256015	30	711220	DCC253	25
705002	ISODC02	20	710555	TCEC385010	30	711230	DCC256	25
705003	ISODC03	20	710560	TCEC386030	30	711240	DCC506	25
705004	ISODC04	20	710580	TCEC506020	30	711250	DCC600	25
705005	ISODC05	20	710595	CTBL25325	30	711260	DCC605	25
705010	ISODC10	20	710605	CTBN25325	30	711270	DCC610	25
705015	ISODC15	20	710615	LSF253	30	711341	PDCUCABBL	25

INDEX OF PART NUMBERS IN NUMERICAL ORDER

Part No.	Reference code	Page	Part No.	Reference code	Page	Part No.	Reference code	Page
711342	PDCUCABBN	25	BMCCAJCAJ	BMCCAJCAJ	65	GTC14Y2	GTC14Y2	61
711343	PDCUCABGY	25	BMCEALEAL	BMCEALEAL	65	GTC14Y3	GTC14Y3	61
711344	PDCUCABST	25	BMCFALFAL	BMCFALFAL	65	GTC14Y4	GTC14Y4	61
711345	PDCUCABWH	25	BMCPALPAL	BMCPALPAL	65	GTC14Y5	GTC14Y5	61
711346	PDCUCABGN	25	BMDGAMGAM	BMDGAMGAM	65	GTC14Y6	GTC14Y6	61
711352	PDCUCJ	25	BMDPAMPAM	BMDPAMPAM	65	GTC16Y0	GTC16Y0	61
711360	PDC506BL	25	BMDPANPAN	BMDPANPAN	65	GTC16Y1	GTC16Y1	61
711370	PC008A	26	BQCBABBAK	BQCBABBAK	65	GTC16Y2	GTC16Y2	61
711380	PC008C	26	BQCEAJEJ	BQCEAJEJ	65	GTC16Y3	GTC16Y3	61
711390	PC010C	26	BQCEALEAL	BQCEALEAL	65	GTC16Y4	GTC16Y4	61
711400	STA253	26	BQCFALFAL	BQCFALFAL	65	GTC16Y5	GTC16Y5	61
711410	STC253	26	BQCPALPAL	BQCPALPAL	65	GTC16Y6	GTC16Y6	61
711430	OBA268	26	BQCPAMPAM	BQCPAMPAM	65	GTC16Y7	GTC16Y7	61
711440	OBC268	26	CC5A04	CC5A04	32	GTC16Y8	GTC16Y8	61
711450	PCT400	26	CC5A05	CC5A05	32	GTC16Y9	GTC16Y9	61
711470	EBL08	41	CC5A20	CC5A20	32	GTC18Y0	GTC18Y0	61
711480	BIM700	26	CC5A30	CC5A30	32	GTC18Y1	GTC18Y1	61
711490	BIM800	26	CC5A40	CC5A40	32	GTC18Y2	GTC18Y2	61
711500	BIM900	26	CCR608S	CCR608S	29	GTC18Y3	GTC18Y3	61
711510	STC256-506	26	CDAS253	DCAS253	25	GTC18Y4	GTC18Y4	61
711520	DT50	42	CMC14CAJ	CMC14CAJ	63	GTC18Y5	GTC18Y5	61
711530	ASCO8	32	CMC16CAJ	CMC16CAJ	63	GTC18Y6	GTC18Y6	61
711550	TAPA253	25	CMC18CAJ	CMC18CAJ	63	GTC18Y7	GTC18Y7	61
711570	TAPC253	25	CNC14CAJ	CNC14CAJ	63	GTC18Y8	GTC18Y8	61
711580	TAPC254	25	CNC14CAM	CNC14CAM	63	GTC18Y9	GTC18Y9	61
711590	TAPC506	25	CNC16CAJ	CNC16CAJ	63	GYE16Y1M	GYE16Y1M	61
711620	TAP5302	28	CNC16CAM	CNC16CAM	63	GYE16Y2M	GYE16Y2M	61
711660	DCC316	25	CNC18FAL	CNC18FAL	63	GYE16Y3M	GYE16Y3M	61
711730	DCA253	25	CPC16PAJ	CPC16PAJ	63	GYE16Y4M	GYE16Y4M	61
711760	DCA600	25	CPC18EAL	CPC18EAL	63	GYE16Y5M	GYE16Y5M	61
166130B	DB-10K16 BLK	44	CSC8A70	CSC8A70	32	GYE16Y6M	GYE16Y6M	61
166140B	DB-12K16 BLK	44	CSP1BNC600	CSP1BNC600	47	GYE16Y7M	GYE16Y7M	61
166160B	DB-10KS16 BLK	44	CSP1BNC90	CSP1BNC90	47	GYE16Y8M	GYE16Y8M	61
166170B	DB-12KS16 BLK	44	CSP1NB600	CSP1NB600	47	GYE18Y1M	GYE18Y1M	61
600PLUSF20	600PLUSF20	51	CSP1NB90	CSP1NB90	47	GYE18Y2M	GYE18Y2M	61
750PLUSF20	750PLUSF20	51	CSP1NMF600	CSP1NMF600	47	GYE18Y3M	GYE18Y3M	61
ATBAS253	ATBAS253	23	CSP1NMF90	CSP1NMF90	47	GYE18Y4M	GYE18Y4M	61
ATBCS253	ATBCS253	23	DB10C701000	DB10C701000	44	GYE18Y5M	GYE18Y5M	61
ATBSS253	ATBSS253	23	DB10C70500	DB10C70500	44	GYE18Y6M	GYE18Y6M	61
B305EGS	B305EGS	55	DB10KS12350	DB-10KS12350	44	GYE18Y7M	GYE18Y7M	61
B305SS	B305SS	55	DCCS253	DCCS253	25	GYJ16Y9M	GYJ16Y9M	61
B305TC	B305TC	55	DCSS253	DCSS253	25	GYJ18Y0M	GYJ18Y0M	61
BACCAK	BACCAK	64	EHL12FC1K	EHL12FC1K	36	GYJ18Y8M	GYJ18Y8M	61
BACEAJ	BACEAJ	64	EHL12FC1K1K	EHL12FC1K1K	36	GYJ18Y9M	GYJ18Y9M	61
BACEAK	BACEAK	64	EHL12FC1V	EHL12FC1V	36	HAAB3CA	HAAB3CA	72
BACFAK	BACFAK	64	EHL12FC2G	EHL12FC2G	36	HAAD2CA	HAAD2CA	72
BACFAL	BACFAL	64	EHL34C1K	EHL34C1K	36	HAAW3CA	HAAW3CA	72
BACFAM	BACFAM	64	EHL34C1V	EHL34C1V	36	HAAY1CA	HAAY1CA	72
BACPAL	BACPAL	64	EHL34C2G	EHL34C2G	36	HAAY2CA	HAAY2CA	72
BACPAM	BACPAM	64	EHL58C1K	EHL58C1K	36	HAAY3CA	HAAY3CA	72
BBCCAJ	BBCCAJ	64	EHL58C1K1K	EHL58C1K1K	36	HBAB3	HBAB3	72
BBCCA	BBCCA	64	EHL58C1V	EHL58C1V	36	HCAY3	HCAY3	69
BBCEAK	BBCEAK	64	EHL58C2G	EHL58C2G	36	HFPDCUC	HFPDCUC	26
BBCEAL	BBCEAL	64	EST3640	EST3640	36	IBTB	IBTB	41
BBCFAJ	BBCFAJ	64	EST4620	EST4620	36	ICECH120C	ICECH120C	30
BBCFAK	BBCFAK	64	EST4630	EST4630	36	ICECH150C	ICECH150C	30
BBCPAL	BBCPAL	64	EST6472	EST6472	36	ICECH185C	ICECH185C	30
BBDPAMPAM	BBDPAMPAM	64	FEB35M10	FEB35M10	40	ICECH50C	ICECH50C	30
BBDPAN	BBDPAN	64	GEM25ABKT	GEM25ABKT	36	ICECH70C	ICECH70C	30
BMCBAKBAK	BMCBAKBAK	65	GTC14Y1	GTC14Y1	61	ICECH95C	ICECH95C	30

INDEX OF PART NUMBERS IN NUMERICAL ORDER

Part No.	Reference code	Page	Part No.	Reference code	Page	Part No.	Reference code	Page
LACY1BAH	LACY1BAH	66	TACY0Y4	TACY0Y4	58	XADY9Y9	XADY9Y9	59
LACY2BAH	LACY2BAH	66	TACY0Y5	TACY0Y5	58	XBCY1Y1	XBCY1Y1	60
LACY3BAJ	LACY3BAJ	66	TACY0Y6	TACY0Y6	58	XBQY4Y4	XBQY4Y4	60
LACY5EAJ	LACY5EAJ	66	TACY0Y7	TACY0Y7	58	XBQY5Y5	XBQY5Y5	60
LACY5FAJ	LACY5FAJ	66	TACY0Y8	TACY0Y8	58	XBQY6Y6	XBQY6Y6	60
LACY6FAJ	LACY6FAJ	66	TACY1Y1	TACY1Y1	58	XBZY6Y7	XBZY6Y7	60
LACY6FAK	LACY6FAK	66	TACY6Y5	TACY6Y5	58	XBZY7Y7	XBZY7Y7	60
LACY7FAK	LACY7FAK	66	TACY6Y6	TACY6Y6	58	XBZY8Y8	XBZY8Y8	60
LACY7FAL	LACY7FAL	66	TACY6Y7	TACY6Y7	58	XBZY9Y9	XBZY9Y9	60
LACY8FAL	LACY8FAL	66	TACY7Y3	TACY7Y3	58			
LACY8FAM	LACY8FAM	66	TACY7Y5	TACY7Y5	58			
LECY6FAJ	LECY6FAJ	67	TACY7Y6	TACY7Y6	58			
LECY6FAK	LECY6FAK	67	TACY7Y7	TACY7Y7	58			
LECY7FAK	LECY7FAK	67	TACY8Y5	TACY8Y5	58			
LECY8FAL	LECY8FAL	67	TACY8Y6	TACY8Y6	58			
LJCCAJY3	LJCCAJY3	67	TACY8Y7	TACY8Y7	58			
LJCCAJY4	LJCCAJY4	67	TACY8Y8	TACY8Y8	58			
LJCEAJY4	LJCEAJY4	67	TACY9	TACY9	58			
LJCEAJY5	LJCEAJY5	67	TACY9Y2	TACY9Y2	58			
LJCFALY6	LJCFALY6	67	TACY9Y5	TACY9Y5	58			
LJCFALY7	LJCFALY7	67	TACY9Y6	TACY9Y6	58			
LJCFAMY8	LJCFAMY8	67	TACY9Y7	TACY9Y7	58			
LJCPAMY9	LJCPAMY9	67	TACY9Y8	TACY9Y8	58			
MBNC82	MBNC82	31	TADY0Y0	TADY0Y0	58			
MBNUPCJ82	MBNUPCJ82	31	TADY0Y9	TADY0Y9	58			
MCCAACKAK	BMCCAACKAK	65	TCECT3160	TCECT3160	30			
PGCY3Y3	PGCY3Y3	60	TCECT5060	TCECT5060	30			
PGCY6Y4	PGCY6Y4	60	TDS502BR300DC	TDS502BR300DC	46			
PGCY7Y4	PGCY7Y4	60	TDS502BR600DC	TDS502BR600DC	46			
PGCY7Y7	PGCY7Y7	60	TDS503BR1000DC	TDS503BR1000DC	46			
PLUSCULD15QC	PLUSCULD15QC	51, 55	VECY1	VECY1	70			
PLUSCULDQC	PLUSCULDQC	51, 55	VFCY2	VFCY2	70			
PTCW8	PTCW8	57	VFCY3	VFCY3	70			
PTCY3Y2	PTCY3Y2	57	VFRY5	VFRY5	70			
PTCY4Y1	PTCY4Y1	57	VSCY0	VSCY0	71			
PTCY4Y2	PTCY4Y2	57	VSCY7	VSCY7	71			
PTCY4Y3	PTCY4Y3	57	VSCY9	VSCY9	71			
PTCY5Y2	PTCY5Y2	57	XACW8W8	XACW8W8	59			
PTCY6Y6	PTCY6Y6	57	XACY2Y1	XACY2Y1	59			
PTCY7Y6	PTCY7Y6	57	XACY3Y1	XACY3Y1	59			
PTCY7Y7	PTCY7Y7	57	XACY4Y1	XACY4Y1	59			
PTCY8Y6	PTCY8Y6	57	XACY5Y2	XACY5Y2	59			
PTCY8Y7	PTCY8Y7	57	XACY5Y3	XACY5Y3	59			
PTCY8Y8	PTCY8Y8	57	XACY5Y4	XACY5Y4	59			
PTCY9Y6	PTCY9Y6	57	XACY5Y5	XACY5Y5	59			
PTCY9Y7	PTCY9Y7	57	XACY6Y3	XACY6Y3	59			
PTDY9Y8	PTDY9Y8	57	XACY6Y4	XACY6Y4	59			
PTDY9Y9	PTDY9Y9	57	XACY6Y5	XACY6Y5	59			
SDT34	SDT34	35	XACY6Y6	XACY6Y6	59			
SDT58	SDT58	35	XACY7Y4	XACY7Y4	59			
SEB08	SEB08	40	XACY7Y5	XACY7Y5	59			
SSCW3	SSCW3	57	XACY7Y6	XACY7Y6	59			
SSCY0	SSCY0	57	XACY7Y7	XACY7Y7	59			
SSCY1	SSCY1	57	XACY8Y5	XACY8Y5	59			
SSCY2	SSCY2	57	XACY8Y6	XACY8Y6	59			
SSCY8	SSCY8	57	XACY8Y7	XACY8Y7	59			
SSCY9	SSCY9	57	XACY8Y8	XACY8Y8	59			
STAS253	STAS253	26	XADY9Y6	XADY9Y6	59			
STCS253	STCS253	26	XADY9Y7	XADY9Y7	59			
STSS253	STSS253	26	XADY9Y8	XADY9Y8	59			

WARNING

Pentair products shall be installed and used only as indicated in Pentair's product instruction sheets and training materials. Instruction sheets are available at www.erico.pentair.com and from your Pentair customer service representative. Improper installation, misuse, misapplication or other failure to completely follow Pentair's instructions and warnings may cause product malfunction, property damage, serious bodily injury and/or death, and void your warranty.

Due to a policy of continuing product development, specifications are subject to change without notice.

ANSI is a registered trademark of American National Standards Institute.

ASTM is a registered trademark of American Society for Testing and Materials.

IEEE is a registered trademark of The Institute of Electrical and Electronics Engineers, Inc.

NEC is a registered trademark of, and National Electrical Code (NEC) standard is a copyright of the National Fire Protection Association.

NFPA is a registered trademark of National Fire Protection Association, Inc.

Surefire is a trademark of The Viking Corporation.



www.erico.pentair.com



AUSTRALIA
Phone 1-800-263-508
Fax 1-800-423-091



CHINA
Phone +86-21-3430-4878
Fax +86-21-5831-8177



HUNGARY
Phone 06-800-16538
Fax +39-0244-386-107



NORWAY
Phone 800-100-73
Fax 800-100-66



SWITZERLAND
Phone 0800-55-86-97
Fax 0800-55-96-15



BELGIUM
Phone 0800-757-48
Fax 0800-757-60



DENMARK
Phone 808-89-372
Fax 808-89-373



INDONESIA
Phone +62-21-575-0941
Fax +62-21-575-0942



POLAND
Phone +48-71-349-04-60
Fax +48-71-349-04-61



THAILAND
Phone +66-2-267-5776
Fax +66-2-636-6988



BRAZIL
Phone +55-11-3623-4333
Fax +55-11-3621-4066



FRANCE
Phone 0-800-901-793
Fax 0-800-902-024



ITALY
Phone 800-870-938
Fax 800-873-935



SINGAPORE
Phone +65-6-268-3433
Fax +65-6-268-1389



UNITED ARAB EMIRATES
Phone +971-4-881-7250
Fax +971-4-881-7270



CANADA
Phone +1-800-677-9089
Fax +1-800-677-8131



GERMANY
Phone 0-800-189-0272
Fax 0-800-189-0274



MEXICO
Phone +52-55-5260-5991
Fax +52-55-5260-3310



SPAIN
Phone 900-993-154
Fax 900-807-333



UNITED KINGDOM
Phone 0808-2344-670
Fax 0808-2344-676



CHILE
Phone +56-2-370-2908
Fax +56-2-369-5657



HONG KONG
Phone +852-2764-8808
Fax +852-2764-4486



NETHERLANDS
Phone 0800-0200-135
Fax 0800-0200-136



SWEDEN
Phone 020-790-908
Fax 020-798-964



UNITED STATES
Phone 1-800-753-9221
Fax +1-440-248-0723